

Connecting Needs with Capabilities

VeriFast™ LVDT

User Manual

Ver. 1.23 – Sept 2023

FDP-VFA-LVD-UM-EL-1.23-0923

Product Sales and Support

The VeriFast™ LVDT is a component of a resistance welding system manufactured by:



For current contact information of various departments (Service, Sales, etc.), as well as CenterLine (Windsor) and Global Affiliate locations, please visit the [Contact Us](#) page on our website:

www.cntrline.com

Head Office:

CenterLine (Windsor) Limited

415 Morton Drive

Windsor ON N9J 3T8

Canada

CAN. 519.734.8464

U.S. 313.962.1448

Toll Free: 800.820.6977

E-mail: info@cntrline.com

Disclaimer

This document is provided for informational purposes only. Due to the variety of uses for the product illustrated in this publication, those responsible for the application and use of this product must satisfy themselves that each application and use of the product meets all applicable laws, regulation codes, and standards. Users of this document should consult applicable federal, state, and local laws and regulations. CenterLine (Windsor) Limited does not, by the publication of this document, intend to urge action that is not in compliance with applicable laws, and this document may not be construed as doing so. CenterLine (Windsor) Limited has made every effort to ensure the accuracy and completeness of this document; however, because ongoing efforts are made to continually improve the capabilities of our products, we cannot guarantee the accuracy of the contents of this document. We disclaim liability for errors, omissions, or future changes herein.

In no event will CenterLine (Windsor) Limited be responsible or liable to any party for any personal injury, property or other damages of any nature whatsoever, whether special, direct, indirect, incidental, consequential or compensatory, directly or indirectly resulting from the publication, use of, or reliance on this document, and also from the use of the equipment described herein.

In issuing and making this document available, CenterLine (Windsor) Limited is not undertaking to render professional or other services for or on behalf of any person or entity. Nor is CenterLine (Windsor) Limited undertaking to perform any duty owed by any person or entity to someone else. Anyone using this document should rely on his or her own independent judgment or, as appropriate, seek the advice of a competent professional in determining the exercise of reasonable care in any given circumstances.

The illustrations, explanations, charts, and layout examples shown in this publication are intended solely for purposes of example. Since there are many variables and requirements associated with any particular installation, CenterLine (Windsor) Limited does not assume responsibility of liability (including intellectual property liability) for actual use based upon the information given in this publication.

Reproduction of the contents of this copyrighted publication, in whole or part, without written permission of CenterLine (Windsor) Limited, is prohibited.

This page is intentionally left blank.

Table of Contents

Preface	7
Who Should Use This User Manual	7
Purpose of This Manual.....	7
Conventions Used in This Manual.....	7
Terminology and Symbols Used Throughout This Manual.....	8
Safety Information	9
Important Safety Information	9
Handling the VeriFast LVDT	9
Potential Hazards Related to VeriFast LVDT	10
Personal Protective Equipment	10
Equipment and Process Overview	11
Intended Use of Equipment	11
VeriFast LVDT Main Components.....	12
VeriFast LVDT Configurations.....	13
Base Mount Styles (Except SXZR).....	13
SYVR Extended Base Mount Style.....	14
SXZR Base Mount Style	14
Tapered and Threaded Mount Styles	15
Clamp Mount Style.....	15
Part Ordering Information	16
Required Services	17
Control Requirements.....	17
Electrical Requirements.....	17
Pneumatic Supply Requirements	17
Water Supply Requirements.....	17
Water Temperature	18
Water Pressure	18
Water Flow.....	18
Installation Guidelines	19
Important Safety Information	19
Pre-Installation Tips and Requirements	19
Mounting the Base Mount Electrode	20
Mounting the Tapered, Threaded, or Clamp Mount Electrode	21
Mounting the Signal Conditioner	22
Wiring the VeriFast LVDT and Signal Conditioner	22
Connecting the Signal Conditioner to the 5-pin Shielded Cable and PLC.....	23
Synchronizing Multiple Signal Conditioners.....	23

Connecting the 5-pin Shielded Cable/Connector to the VeriFast LVDT Electrode	23
Learning about the VeriFast LVDT Signal Conditioner.....	24
Operation of LED Indicators.....	24
Re-Calibrating the Signal Conditioner (This procedure is rarely necessary)	25
Re-Calibrating the Signal Conditioner Remotely (This procedure is rarely necessary)	26
Re-Calibrating the Signal Conditioner for Distinct Applications	26
Determining Effective Resolution	27
Establishing the Pneumatic Service Connection	28
Pneumatic Connection Diagram for LVDT Weld Bodies with Retractable Pin, Using DSCO Valve (Not applicable to Clamp Mount Assemblies).....	28
Pneumatic Connection Diagram for LVDT Weld Bodies with Retractable Pin, Using D3NC Valve (Not applicable to Clamp Mount Assemblies).....	29
Pneumatic Connection Diagram for LVDT Weld Bodies Used in Ring Weld or Clinching Applications (Not applicable to Clamp Mount Assemblies).....	31
Pneumatic Connection Diagram for LVDT Weld Bodies with Non-Retractable Pin (Not applicable to Clamp Mount Assemblies)	31
Pneumatic Connection Diagram for LVDT Clamp Mount Weld Bodies with Retractable Pin	32
Pneumatic Connection Diagram for LVDT Clamp Mount Weld Bodies with Non-Retractable Pin	32
Setup	33
Setting the Tolerance Windows for Fasteners.....	33
Maintenance	34
Important Safety Information	34
Special Caution	34
Servicing the Base (Except SXZR), Tapered, and Threaded Mount LVDT Electrode Assembly	34
Servicing the SXZR Base Mount Style LVDT Electrode Assembly	38
Servicing the Clamp Mount Style LVDT Electrode Assembly	43
Working Area Maintenance	46
Cleaning the Equipment	46
Troubleshooting Quick Guide.....	48
Important Safety Information	48
Troubleshooting Instructions	48
Decommissioning	50
Preparing for Storage	50
Appendix A – Signal Conditioner Connections and Specifications.....	51
Complete Signal Conditioner Electrical Connections.....	51
Signal Conditioner Specifications	52
Index.....	54

Preface

Who Should Use This User Manual

Any person installing, using, or maintaining a VeriFast™ LVDT unit should use this manual.

Purpose of This Manual

This manual describes the function, installation and necessary operating instructions for the proper use of the standard VeriFast LVDT. For assistance with any other customized products or non-standard applications, additional support is available from CenterLine. Please refer to the inside front cover of this manual for CenterLine contact information.



To prevent potentially serious or fatal injury, this manual must be read and understood in its entirety prior to installation, operation, or maintenance of any VeriFast LVDT.

IMPORTANT

While every effort has been made to ensure that the product descriptions, procedures, and installation requirements included in this publication are accurate at the time of printing, CenterLine reserves the right to make product changes that might not be reflected in this document. Should you require additional information, please contact CenterLine, its agents, or distributors for assistance.

Conventions Used in This Manual

This manual uses the following notations:

- Bulleted lists – such as this one – provide information, not procedural steps.
- Numbered lists provide sequential steps to follow or hierarchical information.
- When we refer you to a different section of this manual or to other documentation, the *section*, *chapter*, and *publication title* appear in *italics*.

Terminology and Symbols Used Throughout This Manual

Throughout this manual, all the safety related notes have been identified by the following terms:



This symbol relates information about practices or situations that can lead to personal injury or death, property damage, or economic loss.

Attention statements help you to:

- Identify a hazard.
- Avoid a hazard.
- Recognize the consequences.

IMPORTANT

This symbol relates information that is critical for a successful application and understanding of the product.



This symbol indicates that serious hazards can occur due to pinch points.



This symbol indicates that you should read and understand the User Manual and all other applicable instructions before operating the equipment.



This symbol indicates that the equipment must be disconnected from all sources of power and put in the lockout state.



This symbol indicates that eye protection must be worn as a protection against dust, flying objects and particles.



This symbol indicates that appropriate safety shoes must be worn in order to avoid injuries from exposure to working environment.



This symbol indicates that the equipment must be kept dry, protected from excessive humidity and rain.

Safety Information

Important Safety Information

The VeriFast LVDT is used in conjunction with welding equipment and machinery. Therefore, as a supplement to the safety information offered in this manual for the VeriFast LVDT, all the safety considerations that pertain to the equipment used in conjunction with the VeriFast LVDT still apply and must be followed thoroughly.

Furthermore, all the existing plant safety regulations and other safety instructions from suppliers whose components are used with or around the VeriFast LVDT must be followed accordingly.

Any instructions contained in this manual that directly conflict with any other known safety procedures should be brought to CenterLine's immediate attention for clarification.



- Equipment is not to be modified, adapted, or changed without consulting the relevant sections of this manual or the manufacturer (please refer to the inside front cover of this manual for CenterLine contact information).
 - Before any installation, maintenance, or repair work is started, all sources of energy should be removed from the equipment using proper LOCKOUT procedures for electrical, pneumatic, and water services.
 - Pneumatic and cooling water lines represent potential hazards. Ensure all air and water lines are properly connected and secured prior to turning ON these services.
-

Handling the VeriFast LVDT

In order to prevent potentially serious personal injury, the VeriFast LVDT should be handled, installed, and operated according to the guidelines outlined in this document. Failure to follow the guidelines set forth here will bear unexpected and potentially dangerous results.

IMPORTANT

Handle the VeriFast™ LVDT only by its weld body or base. Do not handle it by the tubing or compression fitting, as these are meant only to protect the LVDT wires inside. See images in Figure 1 below for reference.

If damage occurs to the tubing or wires, the weld body may not work correctly and the LVDT coil may require replacement.

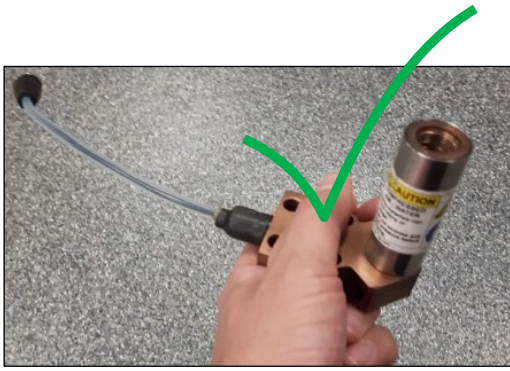

Handling the VeriFast™ LVDT by its weld body or base is

CORRECT

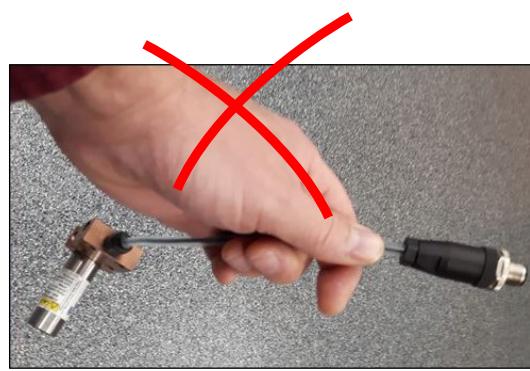

Handling the VeriFast™ LVDT by the tubing or compression fitting is

INCORRECT

Figure 1 – Handling the VeriFast™ LVDT Assembly

Potential Hazards Related to VeriFast LVDT

The VeriFast LVDT system has no specific hazards related to it. However, as the VeriFast LVDT is used in conjunction with other equipment such as welding equipment and machinery, robot, air supply, etc., the user should be aware of the warnings, hazards, and precautions related to the use of the equipment as a whole.



Lockout Equipment

- Before starting to install the VeriFast components on the welding equipment, ensure that the equipment is disconnected from all sources of power and is in the lockout state.
- Before turning ON the equipment, make sure all components are assembled properly.
- Before removing the VeriFast from the welding equipment, make sure the equipment is turned OFF and is in the lockout state.

Personal Protective Equipment

When handling, installing, and operating VeriFast equipment, the following items are recommended in addition to standard safety equipment:



Adequate eye protection, to prevent exposure of the eyes against flying objects, and particles.



Appropriate safety shoes, to protect feet against heavy loads, cuts, flying objects and electrical hazards.

Equipment and Process Overview

Intended Use of Equipment

The VeriFast LVDT is a component of a resistance welding system. When properly installed in conjunction with resistance weld control equipment and used within the system's specification limits, the VeriFast LVDT is used to verify the presence and orientation of fasteners or materials. The VeriFast LVDT is not intended for any other use.

The VeriFast LVDT sensor signal is calibrated to measure and output the position of the fastener (nut or stud) weld pin in various stages of travel. The values of this signal are then compared to peripherally programmed set point values (with tolerances). Results that do not match the set point values can trigger either an interruption in the cycle, or a warning message indicating that the process has fallen outside the set value. These occurrences can indicate a potential part quality issue.

The set point values may indicate:

- Weld Pin Extended Position (System ready to load part and fastener)
- Weld Proceed (Presence and Correct Fastener Orientation)
- Weld Complete (Nut Welded)
- Nut is Upside Down
- No Fastener Detected
- No Part Detected
- Weld Pin Retracted Position (Allowing safe part removal by robot or other process operations)

The VeriFast LVDT system has the ability to detect differences as small as **0.02 mm (0.0009")**. However, actual performance is dependent on the effective resolution of the control system to which it is integrated. For more information refer to section *Determining Effective Resolution* on page 27.

The following example shows a nut application. It demonstrates the difference between correct fastener orientation, and other error conditions.

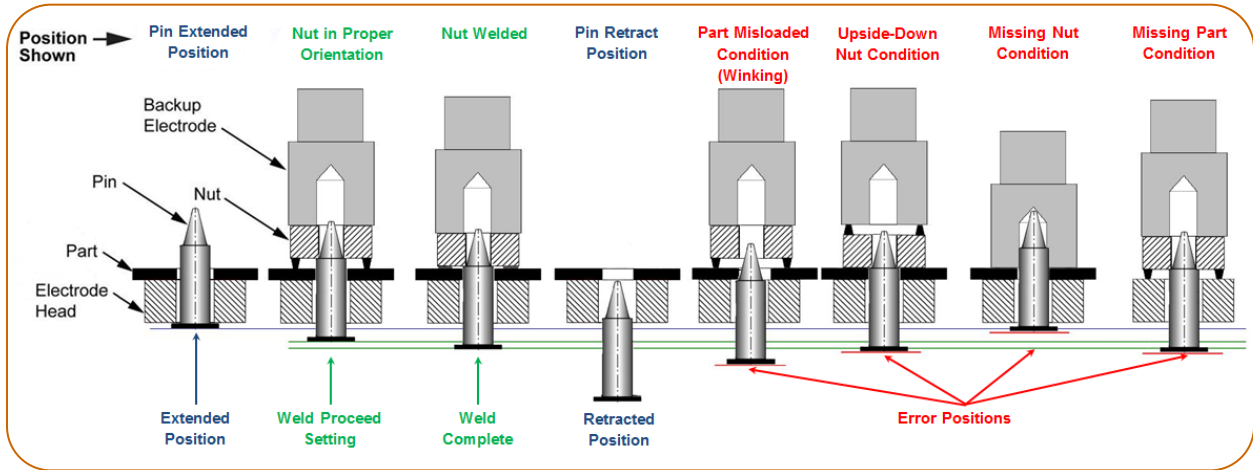

Figure 2 – Nut Detection and Orientation

VeriFast LVDT Main Components

The VeriFast LVDT has a robust construction that allows for fast and easy component changes. A standard VeriFast LVDT configuration is illustrated in Figure 3 below.

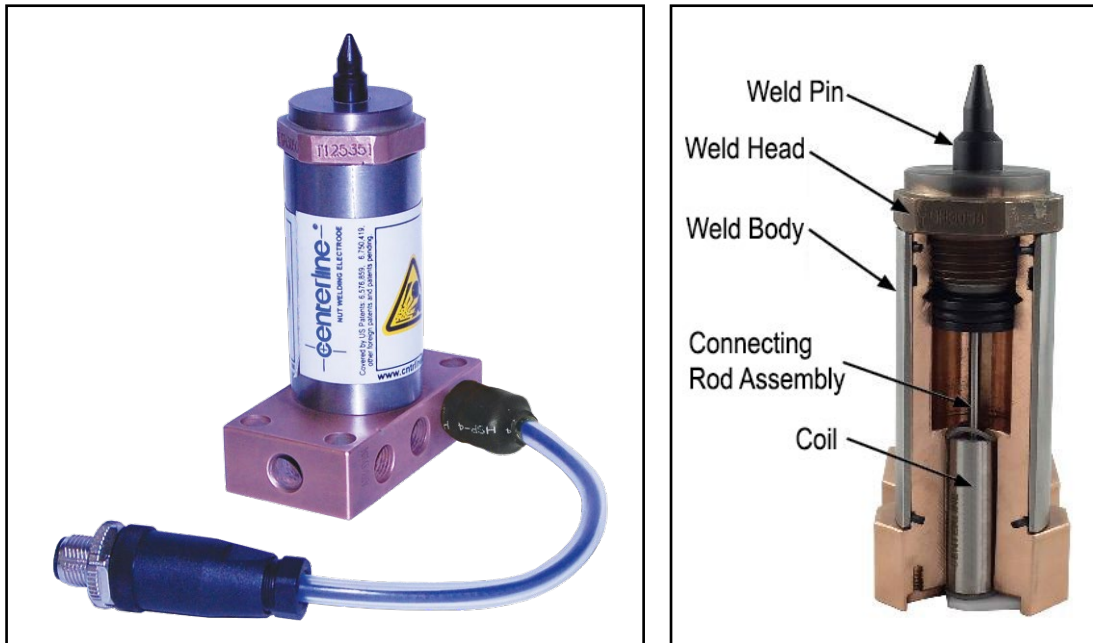
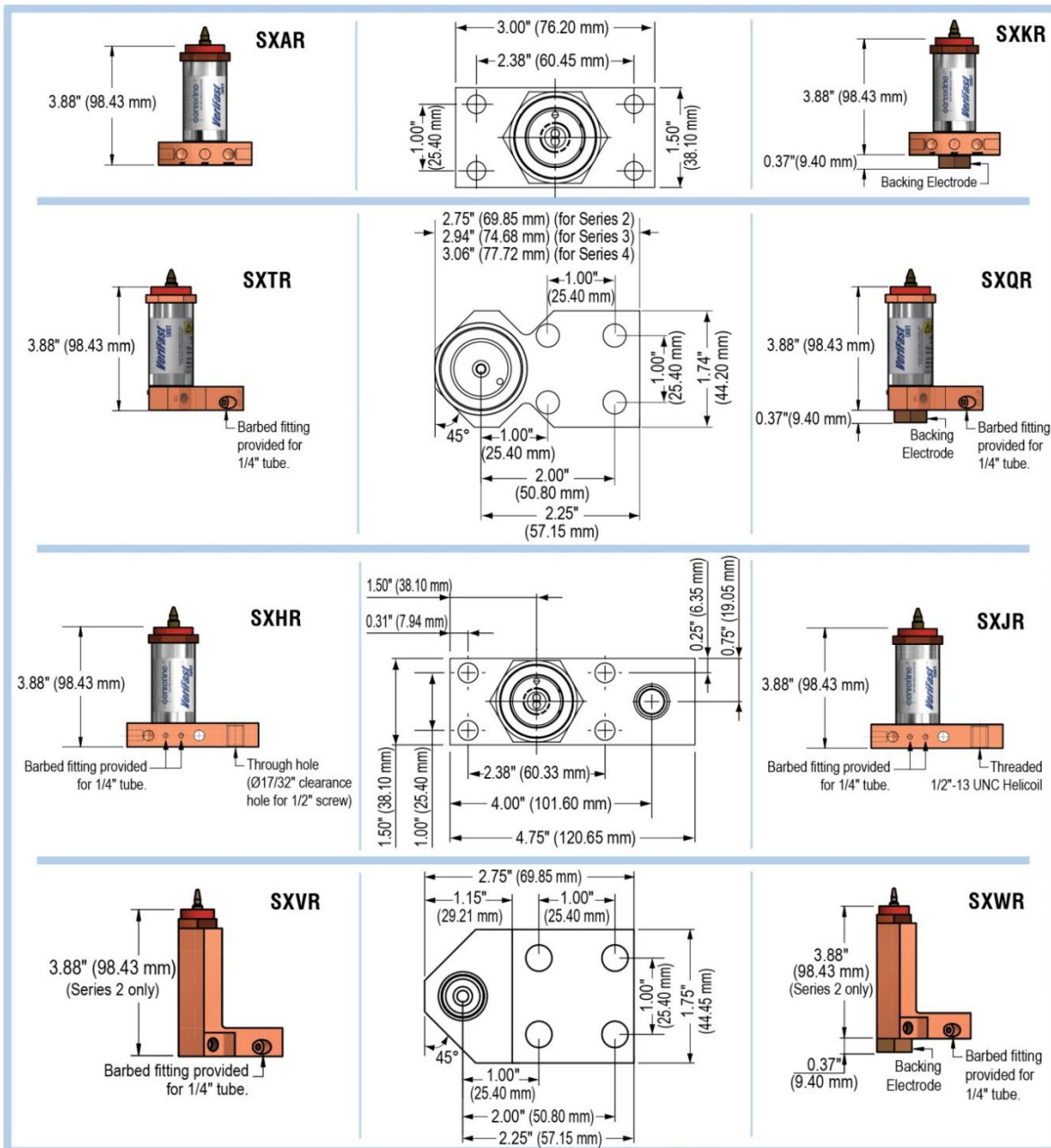

Figure 3 – VeriFast LVDT Configuration

VeriFast LVDT Configurations

Base Mount Styles (Except SXZR)



- All Weld Bodies above work with the following nut and stud weld pins:
- Series 2, 3, and 4 are available for most Base Mount configurations, with Series 3 being preferred for all applications, unless clearance or welding issues exist. Exceptions are SXVR and SXWR weld bodies, which are Series 2 only.
- The Series number must be consistent between all components (Body, Pin, and Head).
- All Weld Bodies above have a 22 mm pin stroke.



Consumable Weld Pin (Only)

Does not include *Connecting Rod Assembly* and *Pin Lock*. Must be assembled with an existing *DG Connecting Rod Assembly* and *Pin Lock* (shown faded underneath).

Connecting Rod Assembly
Pin Lock

SYVR Extended Base Mount Style

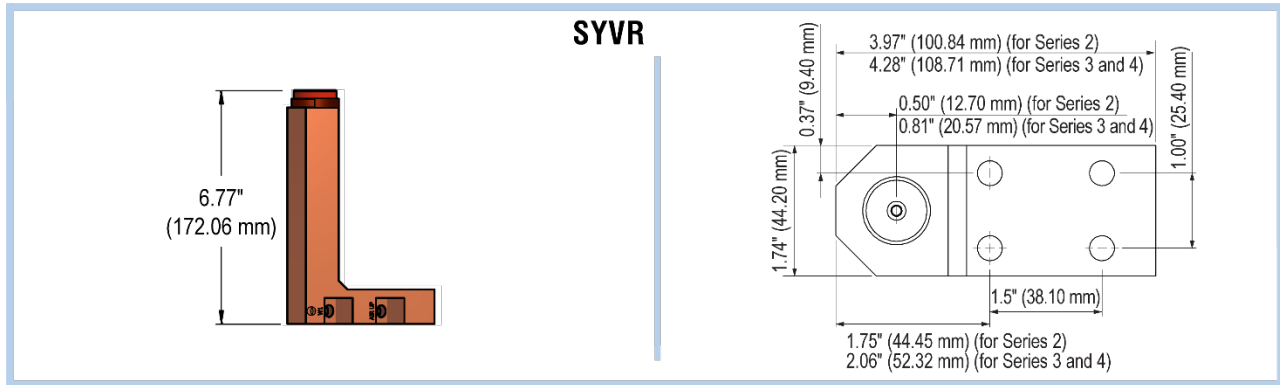

- The SYVR Extended Base Mount weld body works with the following stud weld pin:
- Series 2, 3, and 4 are available for the SYVR configuration.
- Series 3 is preferred for all applications, unless clearance or welding issues exist.
- The Series number must be consistent between all components (Body, Pin, and Head).
- The SYVR weld body is recommended for stud weld applications (not nut applications).
- The SYVR weld body has a 50 mm weld pin stroke only (not 22 mm).

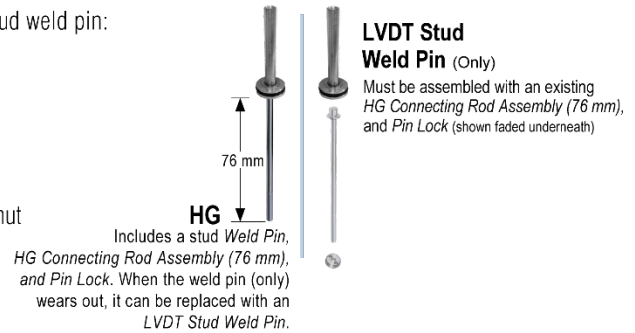

SXZR Base Mount Style

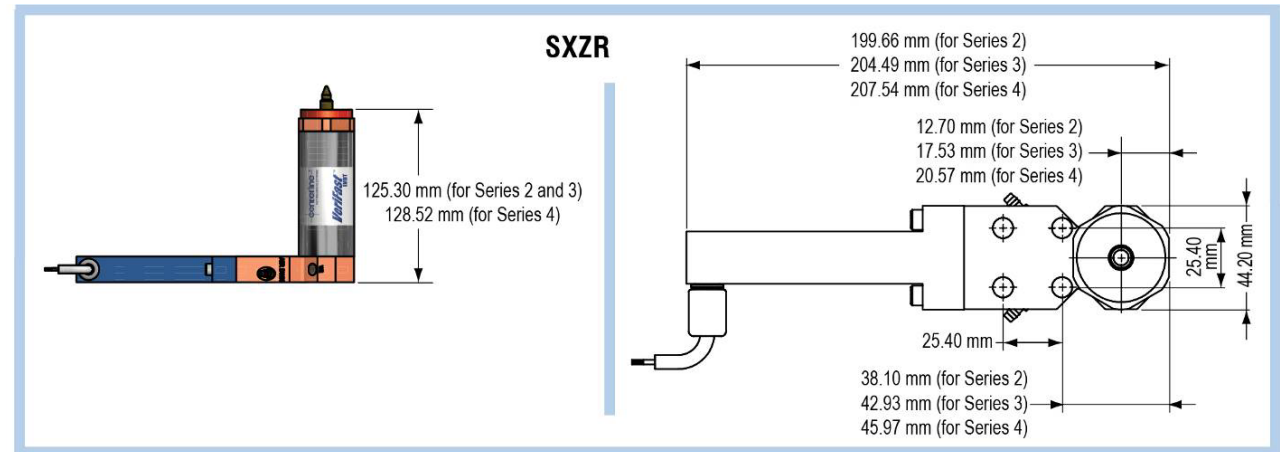

- The SXZR Base Mount weld body works with the following stud weld pin:
- Series 2, 3, and 4 are available for the SXZR configuration.
- Series 3 is preferred for all applications, unless clearance or welding issues exist.
- The Series number must be consistent between all components (Body, Pin, and Head).
- The SXZR weld body is recommended for stud weld applications (not nut applications).
- The SXZR weld body has a 50 mm weld pin stroke only (not 22 mm).



Tapered and Threaded Mount Styles

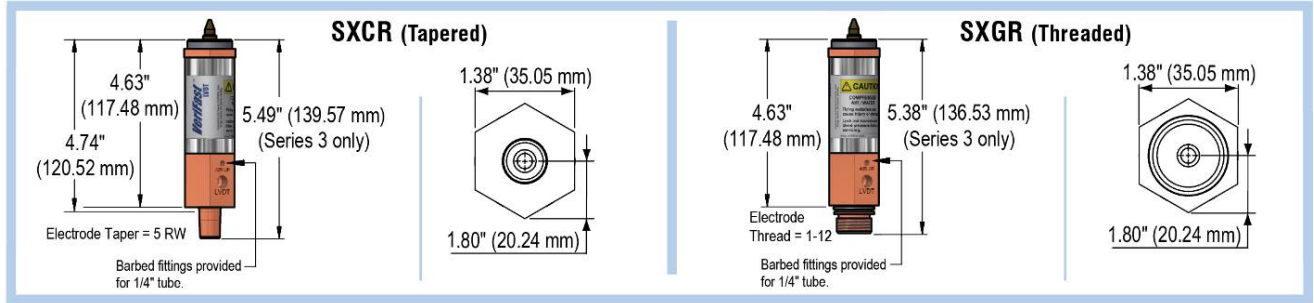

- The above weld bodies work with the following nut and stud weld pins:
- These weld bodies are available in Series 3 only.
- The Series number must be consistent between all components (Body, Pin, and Head).
- The SXCR and SXGR weld bodies have a 22 mm pin stroke.



Includes a nut or stud *Weld Pin*, *DJ Connecting Rod Assembly* (39 mm) and *Pin Lock*.
When the weld pin (only) wears out, it can be replaced with a *Consumable Weld Pin*.

Clamp Mount Style

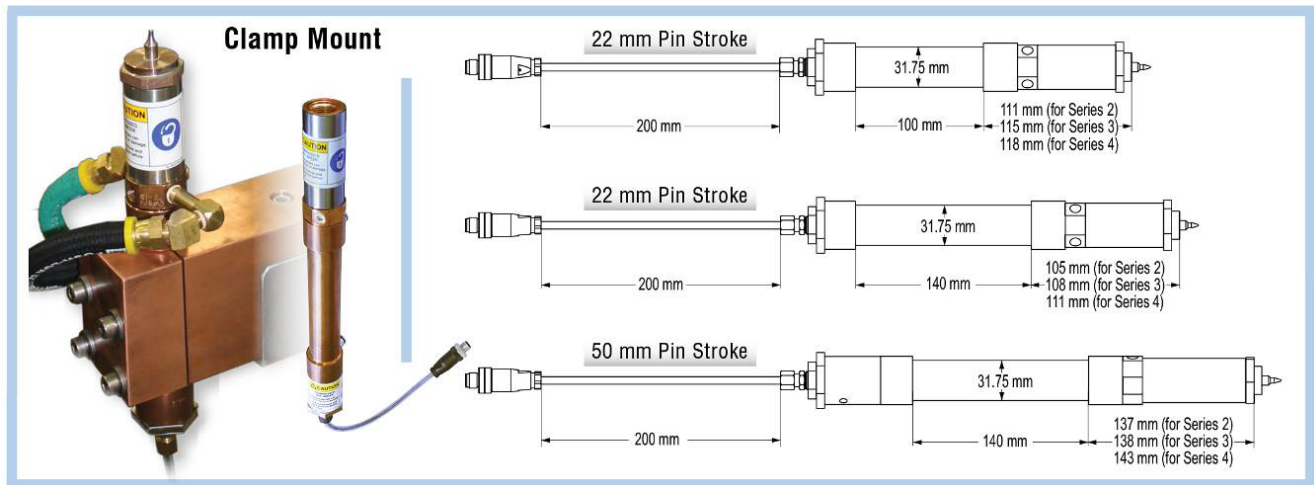

- The Clamp Mount weld body works with the following nut and stud weld pins:
- Series 2, 3, and 4 are available for the Clamp Mount configuration.
- Series 3 is preferred for all applications, unless clearance or welding issues exist.
- The Series number must be consistent between all components (Body, Pin, and Head).
- Adapter Length:
 - 100 (mm) - Works with 22 mm pin stroke only (not 50 mm).
 - 140 (mm) - Works with both 22 mm and 50 mm pin strokes.



- Pin Stroke Length:
 - 22 (mm) - Works with both 100 mm and 140 mm adapters.
 - 50 (mm) - Works with 140 mm adapter only (not 100 mm).

Part Ordering Information

Each VeriFast LVDT component (e.g., weld body, signal conditioner) is marked with labels providing information about your specific configuration. When ordering a replacement component, please check your own equipment and have that specific part number readily available.

If you need to order other components, please refer to the detailed *VeriFast LVDT Part Ordering Instructions brochure* available from CenterLine.

IMPORTANT

For optimal equipment performance and full warranty support, CenterLine consumables must be used.

Required Services

IMPORTANT

When establishing the services (electrical, pneumatic, water) to your VeriFast LVDT, all service requirements illustrated in the current section must be satisfied.

Control Requirements

Minimum recommended control connection requirements are as follows:

An analog input is required to receive the VeriFast LVDT system signal and a 15 bit resolution is recommended to achieve ideal operating performance. Actual performance is dependent on the effective resolution of the control system to which the VeriFast LVDT system is integrated. For more information refer to *Determining Effective Resolution* on page 27.

Electrical Requirements

The VeriFast LVDT power supply requirements are as follows:

- **Volts:** 24 VDC
- **Amps:** 90 mA.

For more electrical specifications, please see the values listed in the *Appendix A – Signal Conditioner Connections and Specifications* section starting on page 51.

Pneumatic Supply Requirements

The operating performance of the VeriFast LVDT is closely tied to the quality and configuration of the air supply system.

- Tubing: M6 (3/8") weld spatter resistant
- Ideal operating pressure: 3.5 bar (50 psi)
- Air shall be filtered and non-lubricated. The air must be clean, dry, and free of contaminants. A pneumatic filter with 5 micron element size is recommended for air cleanliness.
- For installation guidelines, please refer to the *Establishing the Pneumatic Service Connection* section starting on page 25.

Water Supply Requirements

The welding equipment requires water cooling to dissipate the heat generated in the resistance welding process. The operating performance of the equipment is closely tied to the quality and configuration of the water supply system.



- Improper water hookup will result in insufficient cooling, which may cause severe equipment damage or personal injury. Always ensure proper safety precautions.
 - After the cooling circuit is connected, ensure that there are no kinks in any of the lines, and all fittings have been tightened and checked for leaks.
-

The requirements for the cooling water are as follows:

Water Temperature

- Water temperatures between 24°C to 30°C (75°F to 85°F) are recommended.
- The water temperature should not exceed 30°C (85°F) after the load, since high water temperatures will prevent the equipment from being adequately cooled.
- In the event that the water temperature exceeds 30°C (85°F), the equipment should be operated at a reduced duty cycle to prevent damage to the equipment.
- In humid operating environments, ensure that the water temperature is above the dew point to prevent condensation on the equipment.

Water Pressure

- The differential water pressure across the welding equipment (i.e., the difference of the water pressure between the water IN and water OUT) must be 35 PSI or greater to ensure proper water flow.

Water Flow

- The LVDT electrode assembly requires a flow of 1 GPM (4 LPM) to maintain proper operation temperature.

Installation Guidelines

Important Safety Information

Please review the *Safety Information* section starting on page 9 and *Personal Protective Equipment* section starting on page 10.



Before installation procedure for the VeriFast LVDT is started, ensure that all power, air, and water services are de-energized and locked out.

CenterLine recommends that qualified personnel (e.g., electrical or mechanical technician) be involved with the setup and operation of the VeriFast LVDT:

- For mechanical, pneumatic, fluid, and electrical services.
- A qualified weld engineer or quality control personnel – for tolerances and calibration when required.

Pre-Installation Tips and Requirements

Before starting to install the VeriFast LVDT, please be aware of the following:

- If replacing older 'legacy' bodies, the mounting hole pattern of the VeriFast™ LVDT will be different than the existing hole pattern. An adapter plate may be required to mount the LVDT body, as the new mounting holes would be drilled too close to the existing ones.
- Base Mount LVDT weld bodies are approximately 1/2" taller than 'legacy' bodies. Threaded and Tapered mounted LVDT bodies are approximately 1 3/4" taller than 'legacy' bodies.
- If replacing older 'legacy' or Smart Electrode bodies, ensure that the air, water, and electrical connections of the new LVDT weld bodies will work with the existing equipment. Please consider part, tooling and robot clearance.
- CenterLine strongly recommends using Air Blow-By, where air is constantly exhausted past the weld pin to prevent weld spatter from accumulating. Please refer to the *Establishing the Pneumatic Service Connection* section starting on page 28.
- Ensure that the controls solution is adequate, as illustrated by the clear bullets below. (For reference, consult the *Wiring the VeriFast LVDT and Signal Conditioner* section starting on page 22 of this manual. Also, refer to the *VeriFast™ MicroView User Manual* section: "*Wiring the Ports of VeriFast™ MicroView*").
 - If using Signal Conditioners, confirm that the analog card has enough analog channels.
 - If using VeriFast™ MicroView, ensure that enough digital I/O ports are available.
 - Confirm that the correct number and type of cables are available.

Mounting the Base Mount Electrode

IMPORTANT

The weld electrode's mounting on industrial equipment (e.g., platen, sub-plate, etc.) is usually a copper-to-copper contact surface that will transfer current; therefore, both surfaces need to be clean and free from oil, dirt, and any other contaminants.

Any contamination will increase the resistance of the joint, which in turn causes less current to flow and, therefore, an increase in temperature will result. A thin coating of oil from your fingers is enough to cause a change in the resistance. For this reason, it is very important to clean and install the copper components correctly.

Once the surfaces are cleaned, the copper components should be installed immediately, to prevent surface oxidation which will cause a poor connection. As long as the connection remains tight, there should be no concern for heat buildup or loss of current at the connection. If, however, during routine service it is discovered that the joint is loose, then it should be completely disassembled, cleaned and reassembled.

To mount the Electrode Body on machinery or fixture, follow the steps below:

1. Use Scotch-Brite™ to clean the electrode's mounting contact surface. Ensure all pitting and oxidation on the bottom of the weld body is removed. Wipe the surface with a clean cloth.

Pitting and oxidation on the bottom of weld body

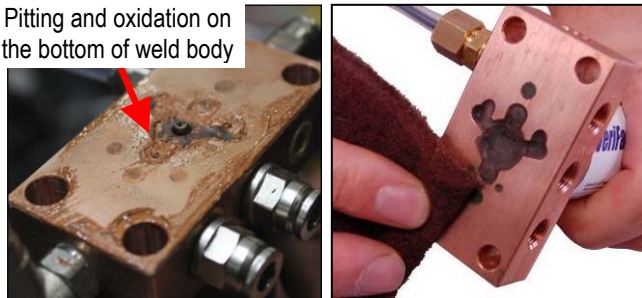

2. Use Scotch-Brite™ to clean the surface of the platen on which the LVDT weld body will be installed. Wipe the surface with a clean cloth.



3. Coat the bottom of the weld body with Kopr-Shield®.



4. Mount the weld body on the sub-plate using the four (4) socket head screws and Nord-Lock washers provided with the equipment. Tighten the screws to 8 N·m (6 ft-lb or 72 in-lb).



Regardless of weld body type, ensure that the bend radius of the LVDT cable is at all times at least 0.79" (20 mm) (see illustrations below as examples). A smaller bend will cause kinks and damages to the LVDT cable.

IMPORTANT



Mounting the Tapered, Threaded, or Clamp Mount Electrode

The mounting procedure for the Tapered, Threaded, or Clamp Mount Electrode is self-explanatory, according to the type of the weld body and the equipment on which the weld body is installed.

IMPORTANT

When the weld electrode is mounted on industrial equipment (e.g., arm of a weld gun, etc.), the contact surface can be **copper-to-copper** or **copper-to-aluminum**. Regardless, all contact surfaces must be clean and free from oil, dirt, and any other contaminants. The recommended cleaning procedure is to wipe the contact areas clean, buff them with Scotch-Brite™, and wipe them clean with a soft cloth. For **copper-to-aluminum** contact components only, be sure to apply Penetrox™ A-13 Electrical Joint to the contact surfaces. The components should then be installed immediately. As long as the connection remains tight, there should be no concern for heat buildup or loss of current at the connection. If, however, during routine service it is discovered that the joint is loose, then it should be completely disassembled, cleaned and reassembled as shown above.

IMPORTANT

Regardless of weld body type, ensure that the bend radius of the LVDT cable is at all times at least 0.79" (20 mm) (see image). A smaller bend will cause kinks and damages to the LVDT cable.



Mounting the Signal Conditioner

The Signal Conditioner is configured to be mounted on a standard DIN rail.

Wiring the VeriFast LVDT and Signal Conditioner

Use a 5-pin shielded cable to establish the connection between the VeriFast LVDT Electrode and Signal Conditioner (see Figure 4 below). Use separate wiring (not shown) to connect the Signal Conditioner to the PLC.

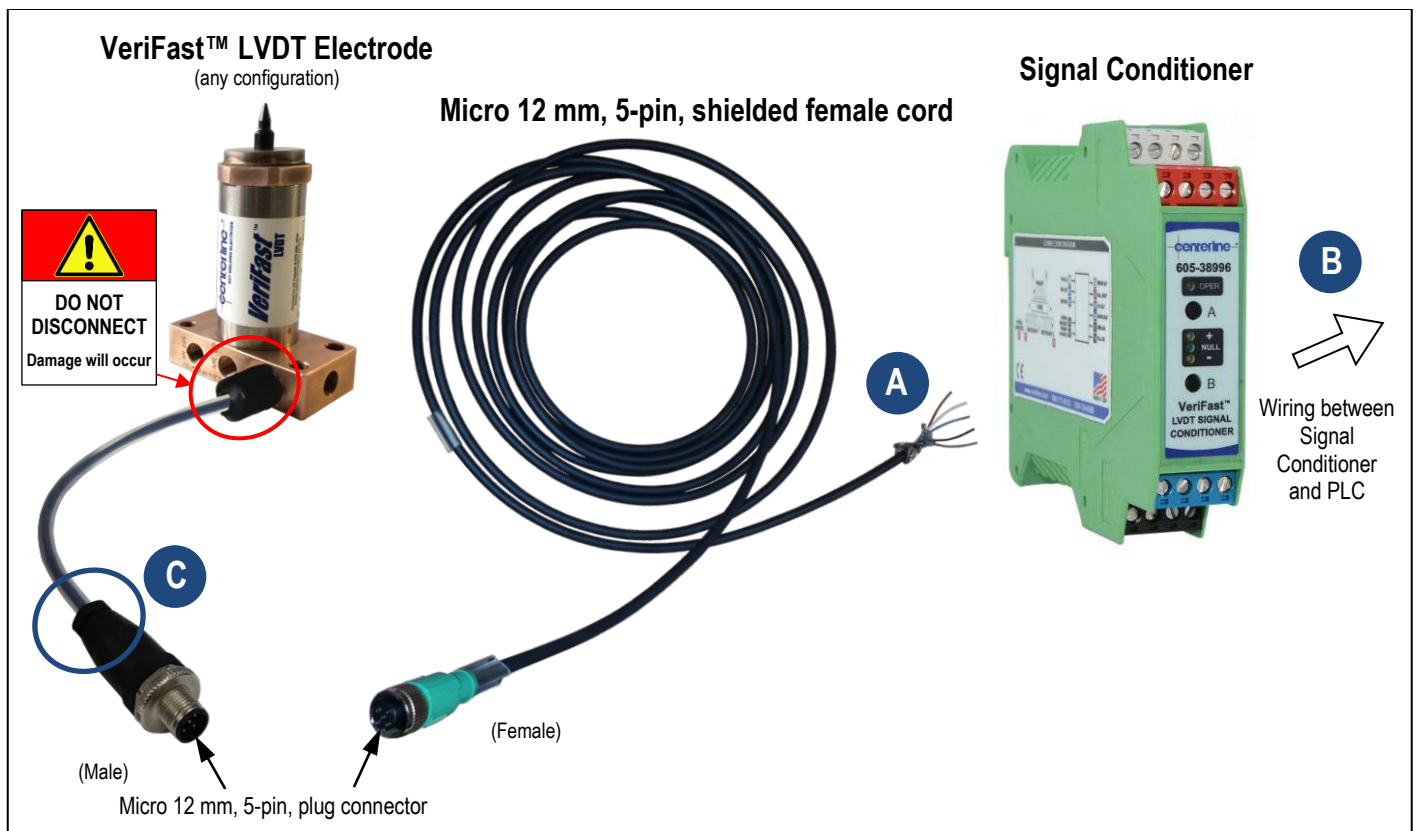

Figure 4 – Wiring the VeriFast LVDT and Signal Conditioner

Connecting the Signal Conditioner to the 5-pin Shielded Cable and PLC

Table 1 – Wiring the Signal Conditioner

From 5-pin Shielded Cable to Signal Conditioner (Marked as A in Figure 4)			
Pin	Wire Color	Terminal	Description
1	Brown	3 (White)	Primary coil 1
2	White	4 (White)	Primary coil 2
3	Blue	7 (Red)	Secondary coil 1
4	Black	8 (Red)	Secondary coil 2
5	Grey + Shield	5 * (Red)	Shield
From Signal Conditioner to PLC (Marked as B in Figure 4)			
		Terminal	Description
		1 (White)	Synchronization
		12 (Blue)	Analog signal
		15 * (Black)	0 V DC
		16 (Black)	24 V DC

* Terminals 5 (shield), 11, and 15 (0 V DC) are internally connected.

Note: For a complete list of all Signal Conditioner electrical connections, see Table 5 in the *Complete Signal Conditioner Electrical Connections* section on page 51 (Appendix A).

Synchronizing Multiple Signal Conditioners

When multiple Signal Conditioners are mounted in close proximity to each other, interference may occur between them because of differences in excitation frequency. This interference may produce noise on the voltage outputs. In order to prevent this from occurring, the VeriFast LVDT Signal Conditioners must be synchronized with each other.

Synchronization of VeriFast LVDT Signal Conditioners is accomplished by connecting the SYNC I/O terminals of each unit into a daisy chain (terminal 1). One unit will automatically assume Master Mode when connected properly with other units.

Once one unit becomes Master, all other units enter Slave Mode. If the current Master ceases to function, the next consecutively connected unit enters Master Mode without user intervention. If a unit is hot swapped or reconnected, it will enter Slave Mode. In an interconnected group of units, one and only one unit is guaranteed to be Master.

Synchronization mode is indicated by the '+' (Yellow) LED for Slave Mode, and the NULL (Green) LED for Master Mode (see Table 3 – Operation of the LED indicators for reference).

Connecting the 5-pin Shielded Cable/Connector to the VeriFast LVDT Electrode

IMPORTANT: This connection (circled red and marked as **C** in Figure 4) is established by CenterLine. Use the information in Table 2 for troubleshooting purposes only.

Table 2 – Connecting the VeriFast LVDT to the 5-pin Shielded Cable/Connector

VeriFast LVDT to 5-pin Shielded Cable (Marked as C in Figure 4)		
Wire Color	Terminal	Description
Brown	1	Primary coil 1
Yellow	2	Primary coil 2
Red	3	Secondary coil 1
Black	4	Secondary coil 2
Shield	5	Shield

Learning about the VeriFast LVDT Signal Conditioner

Operation of LED Indicators

The VeriFast LVDT Signal Conditioner is shown in Figure 5 to the right. The mode of operation for the LED indicators is explained in Table 3 that follows.

For a complete list of all Signal Conditioner electrical connections and technical specifications, please refer to *Appendix A* on page 51.



Figure 5 – LVDT Signal Conditioner

Table 3 – Operation of the LED indicators

LED Name	Function	LED Color During Operation	Status	Description
OPER/ CAL	Module Status	Red	Lit	Normal operation
			Flashing	Calibration mode
(+)	Core Position LEDs	Yellow (+)	Lit	Indicates core is above null position during calibration
			Flashing	Indicates open Primary circuit
NULL		Green (NULL)	Lit	Indicates core is at null position when in calibration mode
				Indicates that the calibration is complete
(-)		Yellow (-)	Lit	Indicates core is below null position during calibration
				Flashing
(+)	Synchronization Status	Yellow (+)	Lit	Indicates this unit is a Slave if multiple units are installed.
NULL		Green (NULL)	Lit	Indicates this unit is the Master if multiple units are installed.

Re-Calibrating the Signal Conditioner (This procedure is rarely necessary)

When delivered to the customer, the VeriFast™ LVDT and Signal Conditioner used with it are calibrated for use with a 22 mm weld pin stroke. If a 50 mm weld pin stroke is being used, re-calibration is necessary. Otherwise, **it is highly unlikely that re-calibration is ever necessary.**

Warning: If multiple weld bodies share a common Signal Conditioner (as, for example, on a FlexFast™ welding machine), calibrating the Signal Conditioner using one weld body from one fixture, may affect the function of the other bodies that share the Signal Conditioner. **Be very cautious to re-calibrate!** However, if you decide that the equipment must be recalibrated, follow the instructions below. **Note:** If desired, 22 mm and 50 mm calibration tools that help with the re-calibration process can be purchased from CenterLine.

Calibrating the VeriFast™ LVDT Signal Conditioner consists of entering Calibration Mode (on the Signal Conditioner) and moving the weld pin to set the extended and retracted positions, which will correspond to the minimum and maximum output voltage. The Signal Conditioner returns to Operating Mode immediately after both positions have been set. (Remote calibration is also available for rare situations. See the next section).

Note: Calibration mode can be cancelled at any time by pressing the buttons 'A' and 'B' (see Figure 7 below) simultaneously for 3 seconds.

In order to re-calibrate the Signal Conditioner, perform the following steps:

1. Access the Signal Conditioner.
Note: If the Signal Conditioner is mounted inside of a MicroView, gain access to the Signal Conditioner by removing the four screws on the left side cover of the MicroView, as shown in Figure 6 on the right.
2. After system power-up, three (3) minutes of warm up time is recommended.
3. Enter the Calibration Mode by pressing both the 'A' and 'B' buttons (see Figure 7) until the OPER LED will begin blinking (3 seconds minimum).
4. Move the Pin to its fully **extended** position and press the 'B' button. Wait for the Position LEDs to stop blinking.
5. Move the Pin to its fully **retracted** position and press the 'A' button.

If the calibration was successful, the unit will exit the Calibration Mode and operate with its new calibration. The OPER LED will be steady ON. Continue directly with Step 6 below.

If the values after calibration are not as expected, see the following **IMPORTANT** note and ignore Step 6.



Figure 6 – Accessing the Signal Conditioner

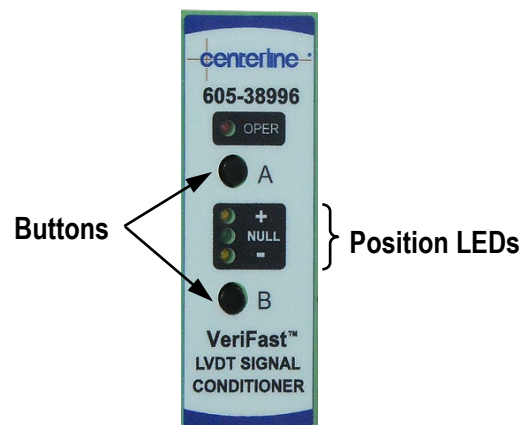

Figure 7 – LVDT Sensor Display and Operating Elements

IMPORTANT

For certain LVDT weld bodies that have geometric variances, following the calibration steps above can repeatedly lead to a failed calibration. In those rare occasions, a slightly modified calibration procedure should be followed, as illustrated in the *Re-Calibrating the Signal Conditioner for Distinct Applications* section starting on page 26.

6. If the calibration process was successful, re-assemble the MicroView by securing the left side cover in its place (see Figure 6 above).

Re-Calibrating the Signal Conditioner Remotely (This procedure is rarely necessary)

The remote calibration yields the same results as the procedure described in the previous sub-section (*Re-Calibrating the Signal Conditioner*), but it is usually least favored by customers since it is more cumbersome.

If you decide that you want to proceed with remote calibration, reference the *Complete Signal Conditioner Electrical Connections* section on page 51 (Appendix A).

At the end of the procedure shown below, the Signal Conditioner will return to Operating Mode immediately after both positions have been set.

1. Start with the weld pin in the Extended Position, and its PLC output ON.
2. Turn ON both the 'Remote Calibration ZERO Input' (Terminal 13) and 'Remote Calibration FULL Input' (Terminal 14) PLC outputs simultaneously for 3 seconds, and then turn OFF.
3. Wait for one (1) second.
4. Turn ON the 'Remote Calibration ZERO Input' PLC output for one (1) second, and then turn OFF.
5. Wait for the 'Remote Calibration Null Output' (Terminal 6), 'Remote Calibration UP Output' (Terminal 9), and 'Remote Calibration DOWN Output' (Terminal 10) PLC inputs to be all OFF. This may take a few seconds.
6. Retract the weld pin and ensure that its PLC output stays ON.
7. Turn ON the 'Remote Calibration FULL Input' (Terminal 14) PLC output for one (1) second, and then turn OFF.
8. The re-calibration of the Signal Conditioner should now be complete.

Re-Calibrating the Signal Conditioner for Distinct Applications

The calibration instructions given below may be performed if the values after calibrating the Signal Conditioner as shown previously (most commonly in the *Re-Calibrating the Signal Conditioner* starting on page 25) are not as expected. At the end of the procedure shown below, the Signal Conditioner will return to Operating Mode immediately after both positions have been set.

Note: Calibration mode can be cancelled at any time by pressing the buttons 'A' and 'B' (see Figure 7) simultaneously for 3 seconds.

To calibrate, perform the following steps:

1. Ensure that the left side cover is still removed from the MicroView (see step 1 in the previous section).
2. Ensure that the unit is warmed up for at least three (3) minutes.
3. Enter the Calibration Mode by pressing both the 'A' and 'B' buttons (see Figure 7) until the OPER LED will begin blinking (3 seconds minimum).
4. Move the Pin to its fully **retracted** position and press the 'A' button once. Wait for the Position LEDs to stop blinking.
5. Move the Pin to its fully **extended** position and press the 'B' button once. The unit will exit the Calibration Mode automatically and operate with its new calibration. The OPER LED will be steady ON.
6. If the calibration process was successful, re-assemble the MicroView by securing the left side cover in its place (see Figure 6 above).

Determining Effective Resolution

In a measurement system, resolution is defined as the smallest increment of position change which can be detected and indicated by the output.

Factors Affecting Analog Resolution

In sensors providing an analog output, practical resolution is determined primarily by:

- The noise on the output and/or signal lines
- The input resolution of the device to which the sensor is connected.

Noise is the main limiting factor in most systems. Even if the resolution of the sensor is theoretically infinite, it's only possible to resolve signal changes that are larger than the amount of noise on the output signal lines. Output changes smaller than the noise level are “lost” in the noise.

Determining Resolution – A Practical Example:

Sensor: VeriFast LVDT

Stroke Length: 22 mm (0.866”)

Output Range: 0-10 V DC

Noise Level: 10 mV

In this example, the infinitely variable output signal of the LVDT sensor is limited by the fact that there is 10 mV of noise present on the signal lines. Since 10 mV is 1/1000th of the entire 0-10 V range, the smallest position change that can be detected is 1/1000th of the working stroke range of 22 mm (0.866”)

$$22 \text{ mm} / 1000 = 0.022 \text{ mm} \quad (0.866'' / 1000 = 0.000866'')$$

So a good, practical estimate of the resolution is 0.022 mm (0.00087”)

Assuming a lower noise level would result in a better estimated resolution (e.g., 5 mV = 0.011 mm (0.0004”))

Input Resolution – Analog inputs on industrial controls must “digitize” an analog signal in order to utilize the information. This is accomplished using an Analog-to-Digital Converter (ADC). An ADC accepts the analog signal and assigns a discrete, digital value to a defined signal value.

For example, a 15-bit ADC can represent a 0-10 V signal as any one of 32,768 “numbers” ($2^{15} = 32,768$). Using the above example:

$22 \text{ mm} / 32,768 = 0.0006713 \text{ mm}$ ($0.866" / 32,768 = 0.0000264"$)

Important! – Note that, in the above example, the limitation as a result of noise is still the determining factor. Even though the input resolution can be as good as 0.0006713 mm ($0.0000264"$), the 10 mV noise level would still limit practical resolution to 0.022 mm ($0.00087"$).

Establishing the Pneumatic Service Connection

The primary function of the compressed air supplied to the VeriFast LVDT is to control the actuation of the weld pin. Based on the Pin type (i.e., Retractable or Non-Retractable), type of application (e.g., nut/stud welding, welding ring projections, clinching applications) and the mount type of the Weld Body (e.g., base, clamp mount, etc.), use one of the pneumatic configurations below. Note that in applications for LVDT Weld Bodies with Retractable Pin, either a DSCO or a D3NC valve can be used, as shown in the first two subsections below (with illustrations in Figure 8 and Figure 9).

Pneumatic Connection Diagram for LVDT Weld Bodies with Retractable Pin, Using DSCO Valve (Not applicable to Clamp Mount Assemblies)

CenterLine recommends using a double solenoid center open (DSCO) valve to extend and retract the weld pin (see Figure 8 below). In this 3-position center open valve, the center open position reduces air consumption when the valve is de-energized. Also, using a 3-port shuttle valve ensures continuous air blow off in all pin positions.

(Note: A D3NC valve can also be used instead of the DSCO valve. See the next sub-section).

While referring to the diagram in Figure 8, please consider the following:

- In home/load position, the solenoid extending the pin should be energized to facilitate loading and locating the stamping and/or location of fastener.
- After a weld complete signal is received, the solenoid extending the pin must be de-energized, and the solenoid to retract the pin must be energized to facilitate the removal of the finished part.

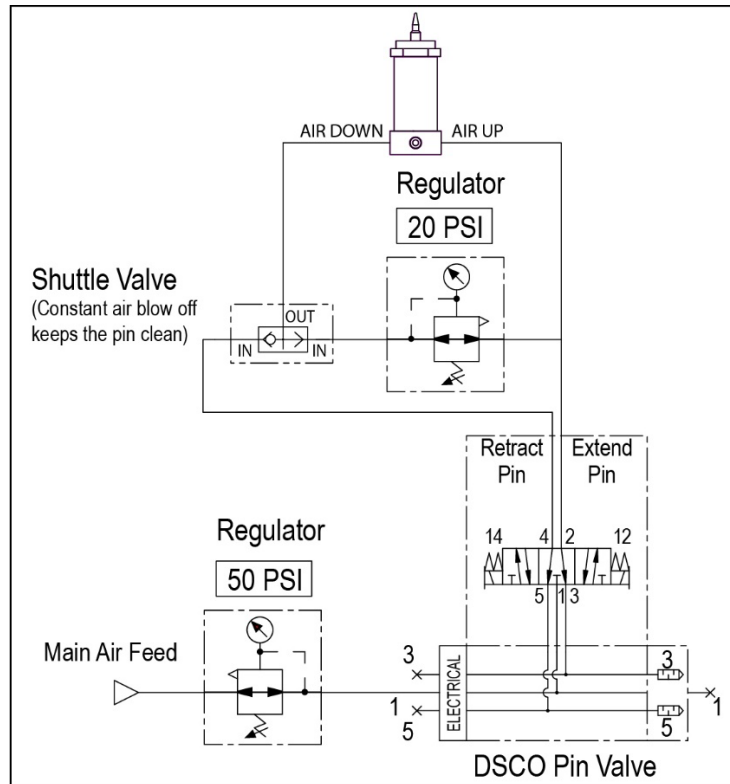

Figure 8 – Pneumatic Connection Diagram for LVDT Weld Body with Retractable Pin, using DSCO Valve (Not applicable to Clamp Mount Assembly)

Pneumatic Connection Diagram for LVDT Weld Bodies with Retractable Pin, Using D3NC Valve (Not applicable to Clamp Mount Assemblies)

CenterLine recommends that a dual 3-way normally closed (D3NC) double solenoid valve can also be used to extend and retract the weld pin, as shown in the pneumatic diagram in Figure 9 below. Note that in this configuration, the D3NC valve would replace the DSCO valve and other pneumatic components shown in Figure 8 above in the previous sub-section.

The benefits of using the D3NC valve are:

- It allows for independent control of the pin extend and retract/air blow off positions.
- Shuttle valve is no longer required.
- The air blow-off is turned ON when the OHMA[®] cylinder intensifies, so smaller fasteners are not being blown off the weld pin.
- It helps provide accurate LVDT readings, as it eliminates the blown off air getting trapped due to the seal created in ring weld applications.
- Eliminates the leaking air noise nuisance.

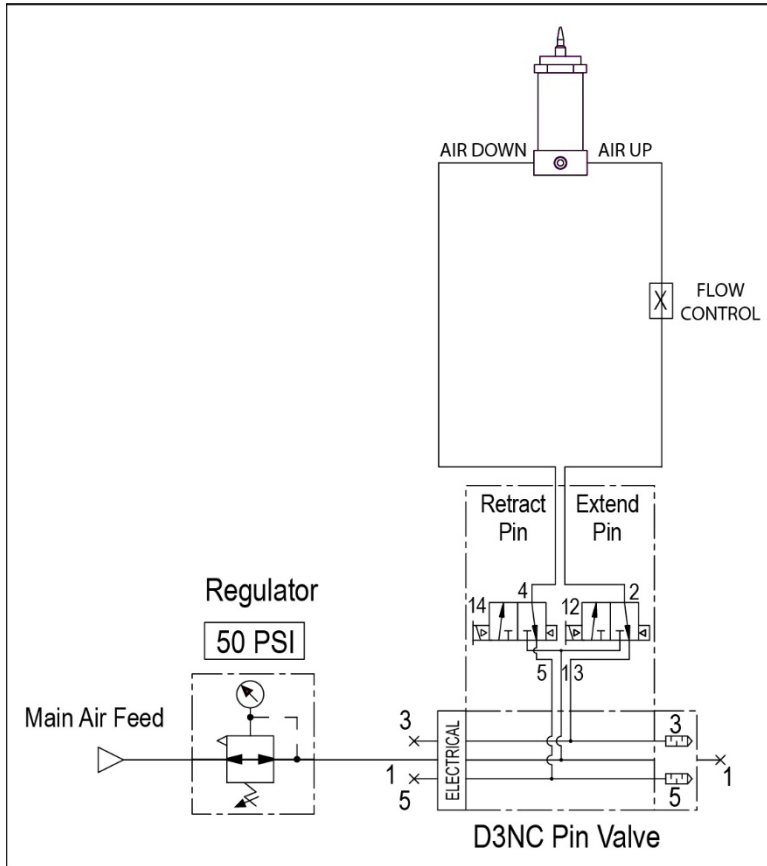

Figure 9 – Pneumatic Connection Diagram for LVDT Weld Body with Retractable Pin, using D3NC Valve
 (Not applicable to Clamp Mount Assembly)

Pneumatic Connection Diagram for LVDT Weld Bodies Used in Ring Weld or Clinching Applications (Not applicable to Clamp Mount Assemblies)

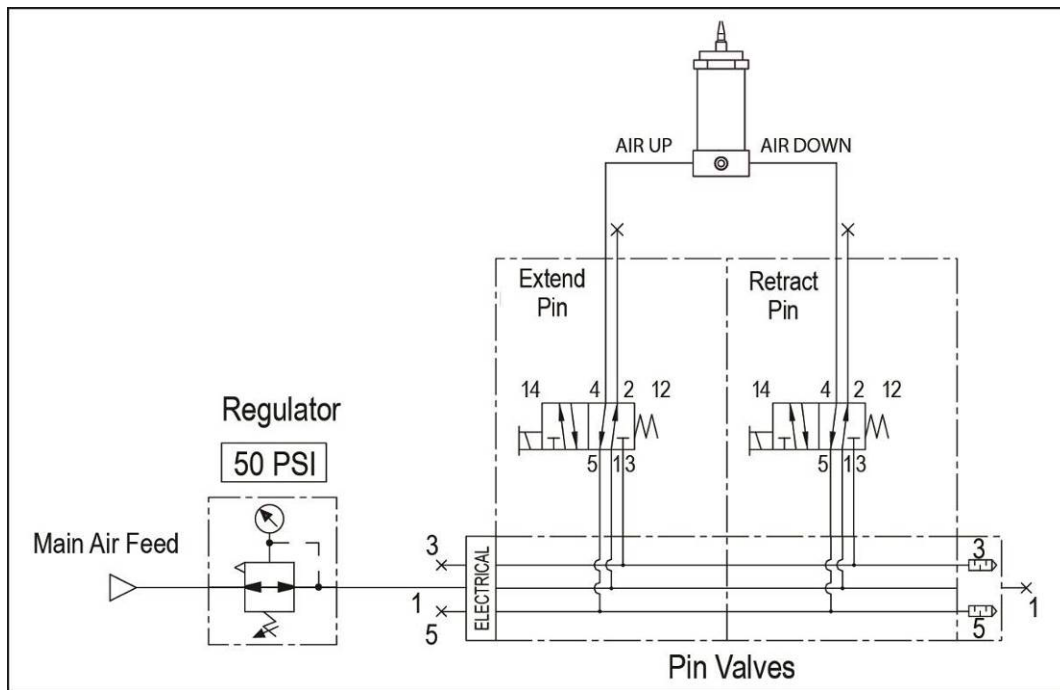

Figure 10 – Pneumatic Connection Diagram for LVDT Weld Body Used in Welding Ring Projections or Clinching Applications (Not applicable to Clamp Mount Assembly)

Pneumatic Connection Diagram for LVDT Weld Bodies with Non-Retractable Pin (Not applicable to Clamp Mount Assemblies)

For proper operation, the AIR UP Regulator **must** be set at a higher pressure than the AIR DOWN Regulator.

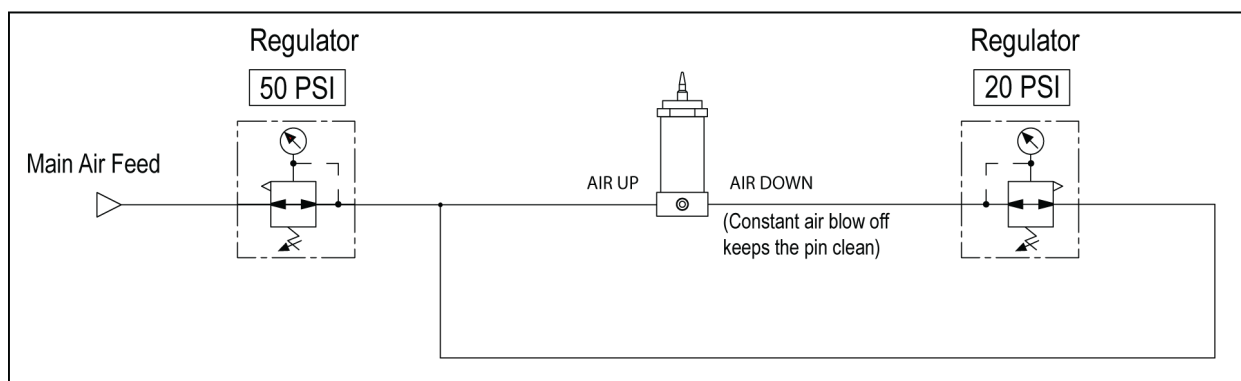

Figure 11 – Pneumatic Connection Diagram for LVDT Weld Body with Non-Retractable Pin (Not applicable to Clamp Mount Assembly)

Pneumatic Connection Diagram for LVDT Clamp Mount Weld Bodies with Retractable Pin

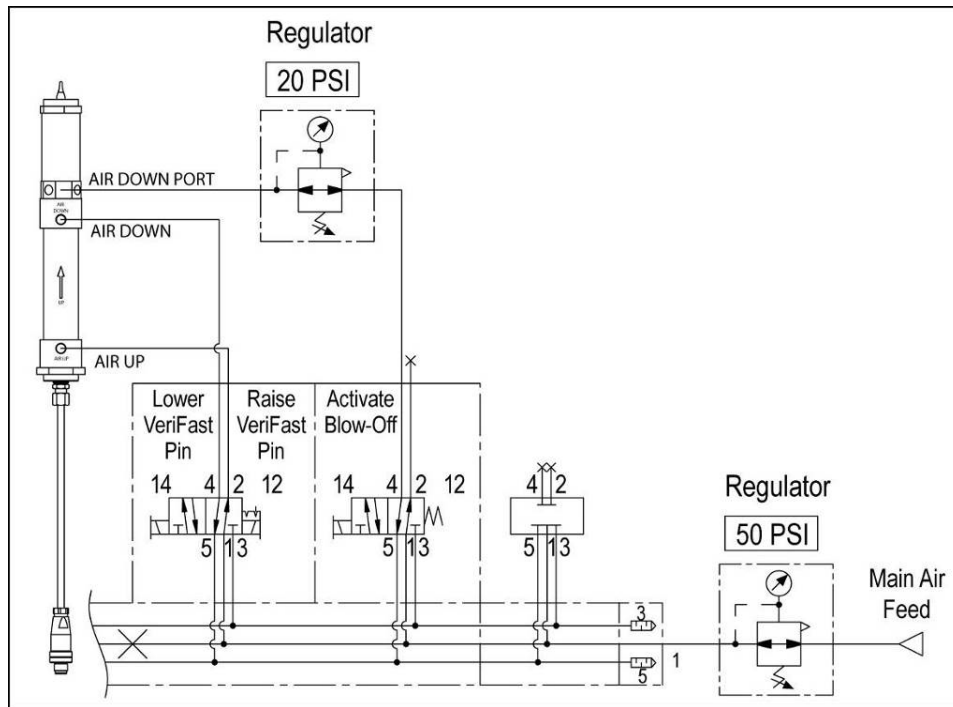

Figure 12 – Pneumatic Connection Diagram for LVDT Clamp Mount Weld Body (Only) with Retractable Pin

Pneumatic Connection Diagram for LVDT Clamp Mount Weld Bodies with Non-Retractable Pin

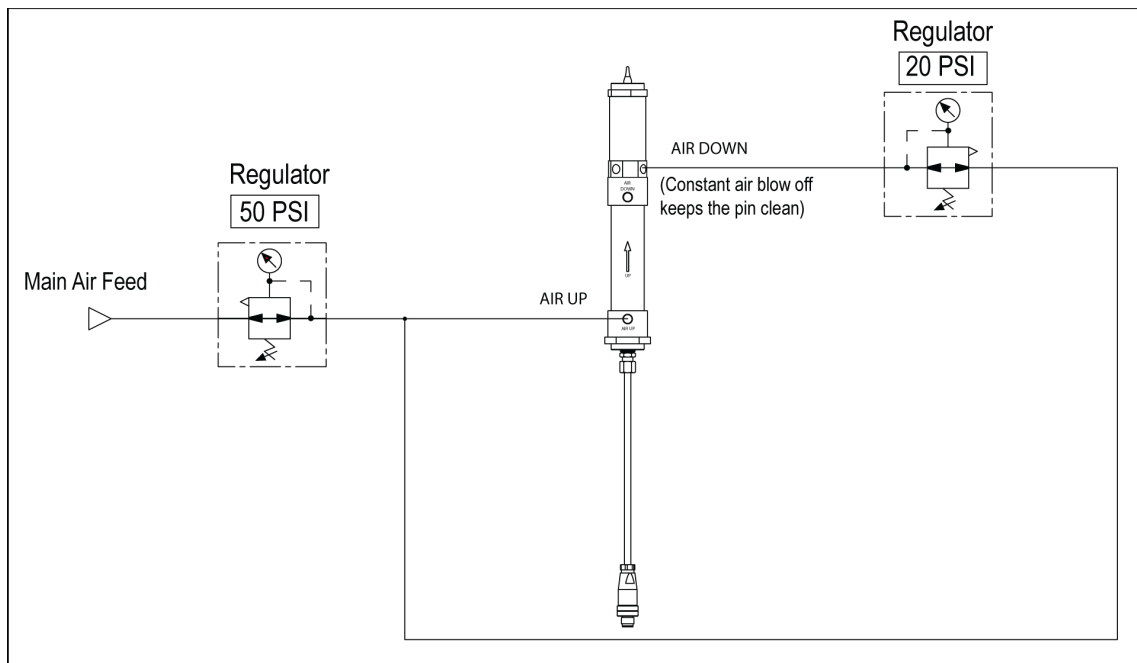

Figure 13 – Pneumatic Connection Diagram for LVDT Clamp Mount Weld Body (Only) with Non-Retractable Pin

Setup

Setting the Tolerance Windows for Fasteners

Use the following instructions to set the tolerance window for the VeriFast LVDT and LPT solutions:

1. Gather a sample of at least ten (10) fasteners that you are using. (Using a greater number of fasteners will produce a more accurate result)
2. Ensure that the selected fasteners are all within dimensional tolerance.
3. With the Weld Pin fully extended, load the stamping and fastener in correct orientation.
4. Advance the weld actuator to make contact with the fastener and record the Weld Pin (LVDT) position.
5. Retract the weld actuator, ensuring that the Weld Pin returns to fully extended position.

Note: Steps 6, 7, and 8 below only apply when welding Nuts. Skip to Step 9 if welding Studs.

6. (*Nuts only*) Remove the fastener, and re-load it in upside down orientation.
7. (*Nuts only*) Advance the weld actuator and record the Weld Pin (LVDT) position.
8. (*Nuts only*) Retract the weld actuator, ensuring that the Weld Pin returns to fully extended position.
9. Repeat Steps 1 through 5 (include Steps 6, 7 and 8 if nut welding) for the entire sample of fasteners.
10. Average all correctly placed fastener readings. If nuts are being used, average the upside down readings as well.
11. Select a tolerance that will reliably allow correctly placed fasteners to proceed, while always rejecting upside down fasteners. See the Example to the right for illustration.

Note: If there are similar fasteners in the vicinity that could also be mistakenly loaded onto this electrode, these should also be checked to verify that they cannot be welded.

It is important to keep in mind that the tolerance window must be small enough to reject all upside down fasteners, while large enough to accept stamping and fastener variances. If the Correct and Upside Down windows overlap, a different Weld Pin design may be necessary. Please contact CenterLine for more details.

Example

Fastener #	Correct	Upside Down
1	13,356	15,223
2	13,478	15,336
3	13,322	15,347
4	13,415	15,358
5	13,345	15,213
6	13,449	15,374
7	13,411	15,346
8	13,301	15,339
9	13,463	15,260
10	13,383	15,289
Average	13,392	15,309
Max	13,301	15,209
Min	13,478	15,374

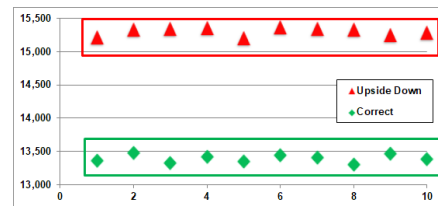

In this case, set the tolerance at 13,400 with a range of ± 300 counts. The 'pass' window would be between 13,100 and 13,700. This allows every correctly loaded fastener to be welded, while rejecting every incorrectly loaded fastener.

Maintenance

Important Safety Information

IMPORTANT

Situations not covered in this section should be referred directly to CenterLine for further assistance (Please refer to the inside front cover of this book for CenterLine contact information).

Please review the *Safety Information* section starting on page 9 and *Personal Protective Equipment* section starting on page 10.

Special Caution

Regardless of configuration, **do not attempt to remove/loosen the sleeve or fitting on the VeriFast LVDT Electrode. Damage to the equipment will occur!**



Servicing the Base (Except SXZR), Tapered, and Threaded Mount LVDT Electrode Assembly

Important: For SXZR and Clamp Mount styles, please see the sections that follow.

Although the VeriFast LVDT unit is a sealed, low maintenance device, the Weld Pin and the Electrode Head need to be replaced at regular intervals. In addition, by following the procedure illustrated below, other internal components can be inspected and/or replaced as needed.

Note: As long as the Connecting Rod Assembly and Pin Lock are in good shape, they can be reused multiple times with new VeriFast LVDT Weld Pins.

Step 1

Remove the air and water services from the system. Then, unthread and remove the Electrode Head from the Weld Body.



Step 2

Remove the used Weld Pin and Connecting Rod Assembly from the Electrode Body.



Step 3

If the Connecting Rod and Pin Lock are in good shape, they can be disassembled from the used weld pin and reused with a new Weld Pin. To start this procedure, use a rag to protect the used weld pin and install the pin upside down in a vise. Continue with Step 4 below.

Otherwise: If the Weld Pin and Connecting Rod Assembly are being replaced as a whole assembly, protect the new weld pin with a rag and install the pin upside down in a vise. Then, skip directly to Step 13 on page 37.

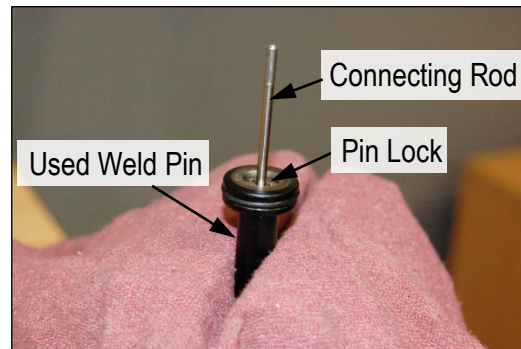

Step 4

Use the Hex Tool (provided with your equipment) and a wrench to loosen the Pin Lock from the used Weld Pin.

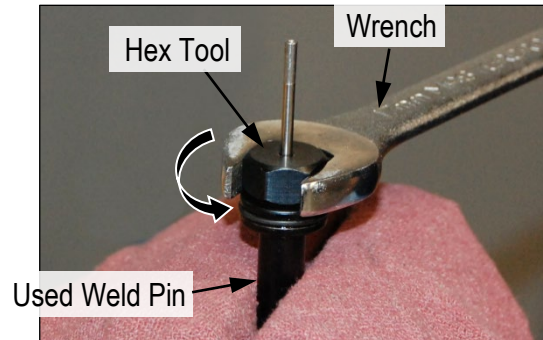

Step 5

Remove the Connecting Rod Assembly and Pin Lock, and set them aside for future use. Discard the used Weld Pin.



Step 6

Thoroughly shake the bottle of Loctite 243 Threadlocker (blue color). Apply one drop of Loctite onto the outer side of the thread of the new weld pin.

Then, rotate the weld pin 180° and apply one more drop diametrically opposed.

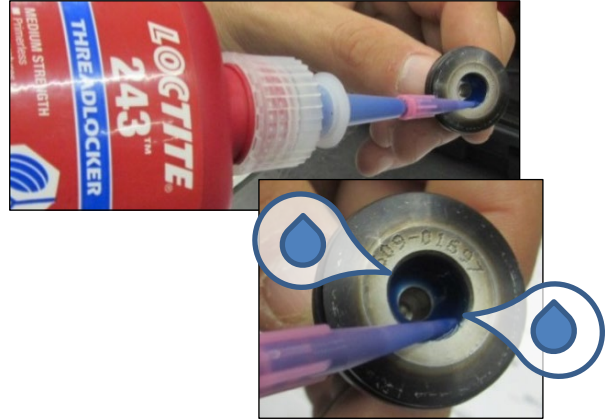

Step 7

Place the new Weld Pin upside down into the vise, protected by the rag.

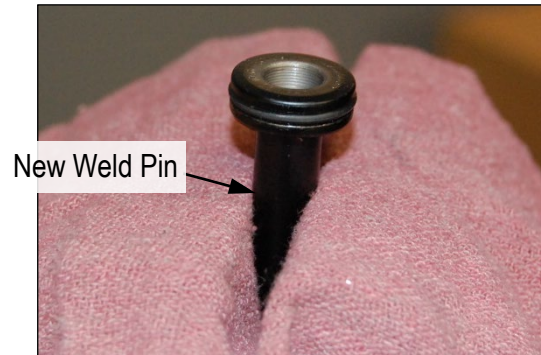

Step 8

Apply one drop of Loctite 243 Threadlocker (blue color) onto the threads on the Pin Lock. Then, rotate the weld pin 180° and apply one more drop diametrically opposed.



Step 9

Using the Hex Tool, thread the Pin Lock (with the Connecting Rod Assembly) onto the base of the new Weld Pin, being careful not to cross the threads.



Step 10

Use a torque wrench and a 17 mm deep socket to tighten the Pin Lock into the Weld Pin.

Note: Do not over tighten!
Maximum 30 in./lbs (3.4 Nm).

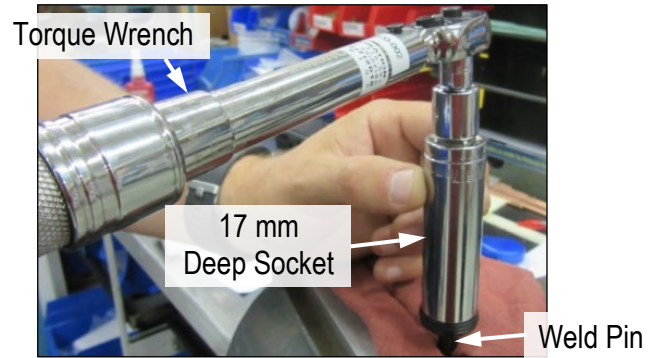

Step 11

Very Important: After tightening, ensure that the Connecting Rod Assembly is tight and cannot move or rotate relative to the Weld Pin. The Pin Lock must sit flush or below the base of the Weld Pin.

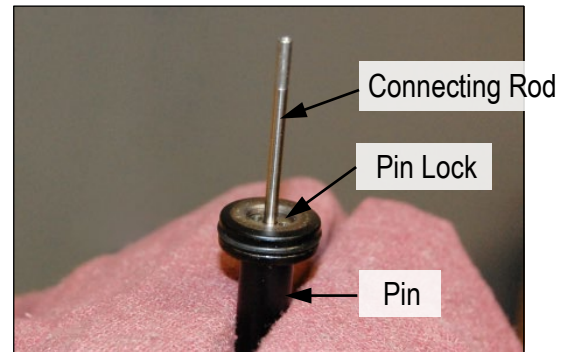

Step 12

Use a marker to place a mark across the Pin Lock and base of the Weld Pin. The mark will provide an indication of the Pin Lock loosening during use.



Step 13

Apply a small amount of grease to the O-ring on the Weld Pin (**Note:** Magnalube-G grease is recommended).

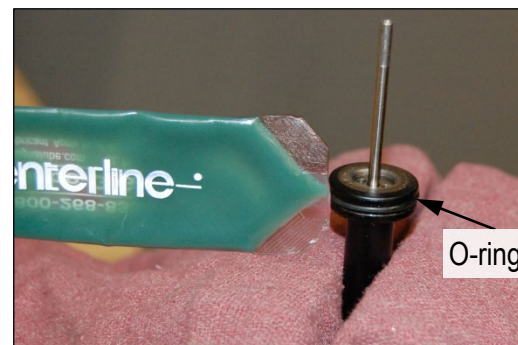

Step 14

Remove the Weld Pin from the vise. Insert the new Pin/Connecting Rod Assembly into the Electrode Body. Carefully allow the Core and inner bore of the Electrode Body to guide the insertion.



Step 15

Thread on the Electrode Head and tighten to the corresponding torque (according to the weld body series):

- 15 ft/lbs. – for Series 2 weld bodies
- 30 ft/lbs. – for Series 3 weld bodies
- 100 ft/lbs. – for Series 4 weld bodies.



Servicing the SXZR Base Mount Style LVDT Electrode Assembly

Although the VeriFast LVDT SXZR Base Mount Assembly is a sealed, low maintenance device, the Weld Pin and the Electrode Head need to be replaced at regular intervals. In addition, by following the procedure illustrated below, other internal components can be inspected and/or replaced as needed.

Step 1

Remove the air and water services from the system.



Step 2

Unthread and remove the Weld Head.

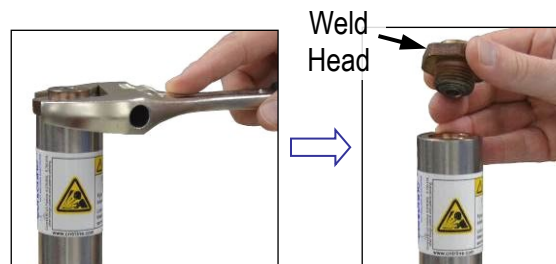

Step 3

Gently remove the used Weld Pin from the Weld Body, altogether with the whole LVDT Cable Assembly that is attached at the bottom of the weld pin. Slightly twisting the weld pin while pulling it may help the cable find its way out.



Step 4

Inspect the Cable Assembly and ensure that the LVDT Cable has no kinks or bends, and the LVDT Core is intact and in correct position.

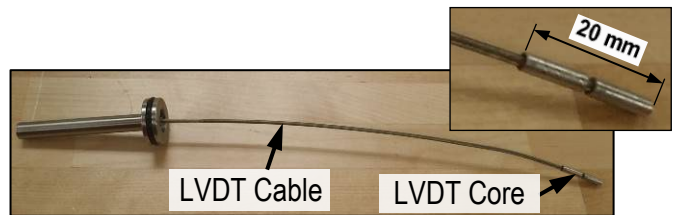

Step 5

If the LVDT Cable Assembly and Pin Lock are in good shape as shown in the previous step, they can be disassembled from the used Weld Pin and perhaps reused with a new Weld Pin. To start this procedure, protect the used weld pin with a rag, then install the pin upside down in a vise. Continue with Step 6 below.

Otherwise: If the Weld Pin and LVDT Cable Assembly are being replaced as a whole assembly (**note that CenterLine® recommends this option!**), protect the new weld pin with a rag and install the pin upside down in a vise. Then, skip directly to Step 15 on page 42.

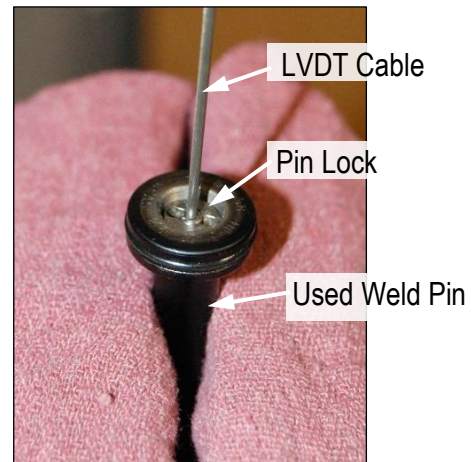

Step 6

Slide the Hex Tool over the LVDT Cable and fit its pegs into the holes of the Pin Lock. Using a wrench, rotate the Hex Tool altogether with the Pin Lock to unthread the Pin Lock from the bottom of the old Weld Pin.

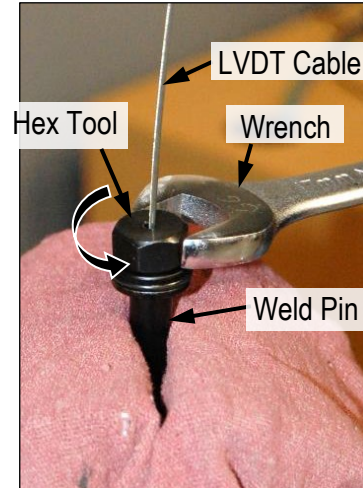

Step 7

Carefully inspect the Ferrule at the newly exposed end of the cable (see images on the right):

If the Ferrule is in good condition, the LVDT Cable Assembly can be reused. Set the LVDT Cable Assembly and Pin Lock aside for future use. The Hex Tool can stay on the LVDT Cable Assembly for now. Discard the used Weld Pin and continue with Step 8 below.

If the Ferrule is in bad condition (crushed), the LVDT Cable Assembly cannot be reused. Discard the LVDT Cable Assembly altogether with the used Weld Pin. Proceed with a new Weld Pin and LVDT Cable Assembly instead. Protect the new weld pin with a rag and install the pin upside down in a vise (for guidance see the illustration in Step 5 above). Then, skip directly to Step 15 on page 42.

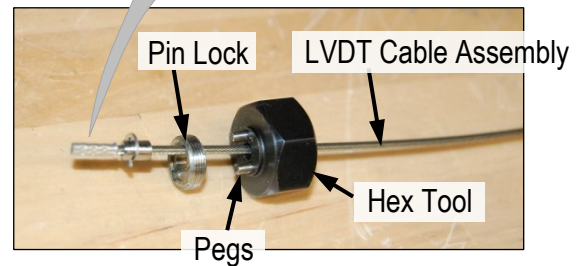
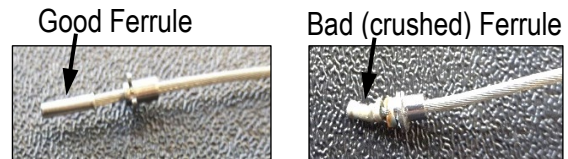

Step 8

Thoroughly shake the bottle of Loctite 243 Threadlocker (blue color). Apply one drop of Loctite onto the outer side of the thread of the new weld pin.

Then, rotate the weld pin 180° and apply one more drop diametrically opposed.

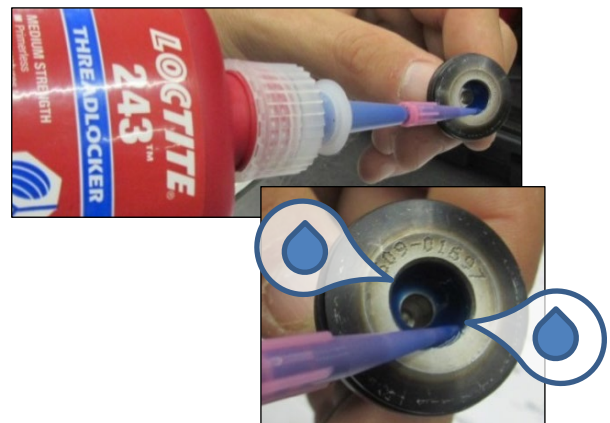

Step 9

Place the new Weld Pin upside down into the vise, protected by the rag.

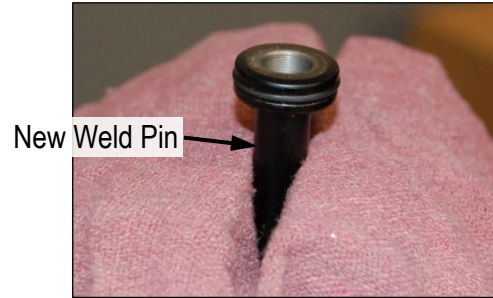

Step 10

Slide the Pin Lock (sunken side first) onto the Cable Assembly. Ensure that the E-Clip Disc fits properly into the sunken area of the Pin Lock.

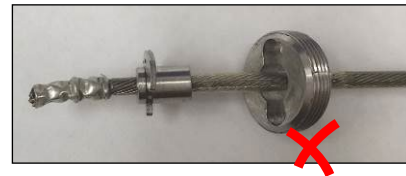
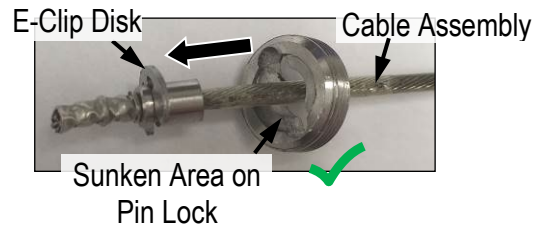

Step 11

Apply one drop of Loctite 243 Threadlocker (blue color) onto the threads of the Pin Lock. Then, rotate the weld pin 180° and apply one more drop diametrically opposed.

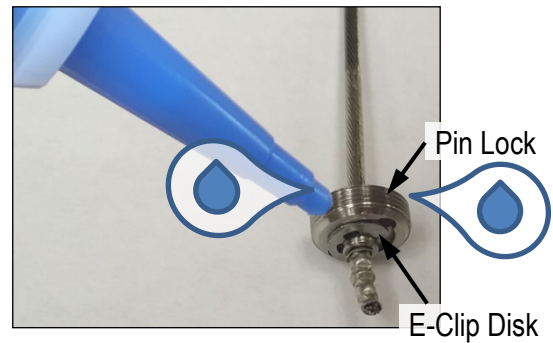

Step 12

Fit the pegs of the Hex Tool into the holes of the Pin Lock. **Note:** To keep all the components in place, keep the cable under tension by gently pulling its other end with your other hand.

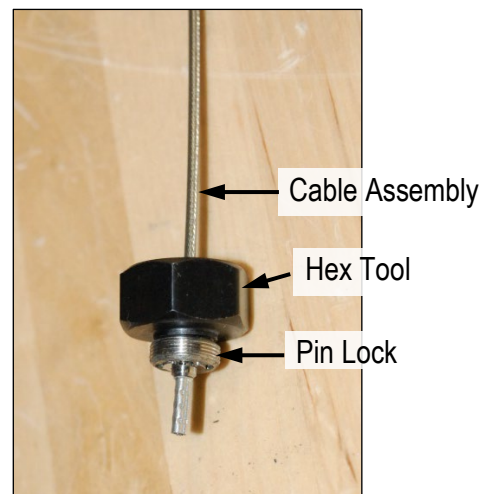

Step 13

Using a wrench to turn the Hex Tool, thread the Pin Lock (with the Cable Assembly) onto the base of the Weld Pin, being careful not to cross the threads. Wipe off any excess Loctite.

Note: Do not over tighten! Maximum 30 in./lbs (3.4 Nm).

VERY Important: After the procedure, check that the Pin Lock and the LVDT Cable are tight and do not move or rotate relative to the Weld Pin. The Pin Lock must sit flush or below the base of the pin. The cable should have no play.

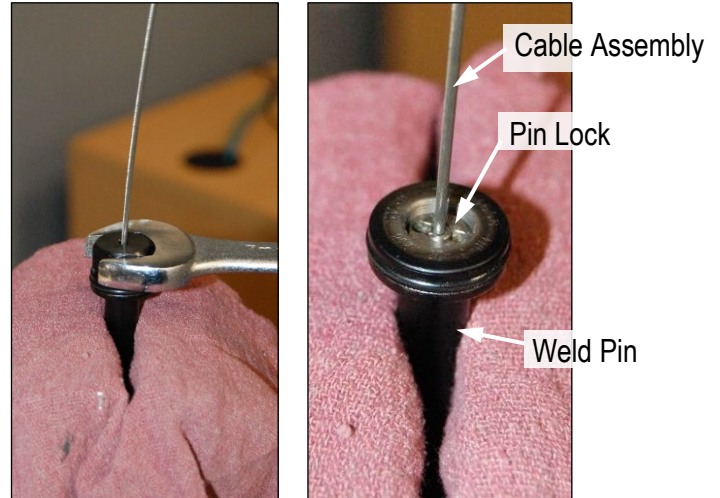

Step 14

Use a marker to place a mark across the Pin Lock and base of the Weld Pin. The mark will provide an indication of the Pin Lock loosening during use.



Step 15

Apply a small amount of grease to the O-ring on the new Weld Pin (Note: Magnalube-G grease is recommended). Then, remove the Weld Pin from the vise.

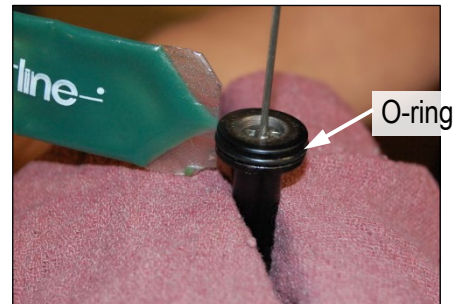

Step 16

Gently insert and fully slide the LVDT Cable Assembly through the hole in the bottom center of the Weld Body, until the Weld Pin will properly sit inside the Weld Body.

During this process, slightly twisting the cable or using needle nose pliers may help to gently guide the LVDT Cable Assembly through the hole.



Step 17

Ensure that the Weld Pin moves freely up and down inside the Weld Body (with no constraint from the LVDT Cable Assembly).

Then, thread on the Electrode Head and tighten to the corresponding torque (according to the weld body series):

- 15 ft/lbs. – for Series 2 weld bodies
- 30 ft/lbs. – for Series 3 weld bodies
- 100 ft/lbs. – for Series 4 weld bodies.

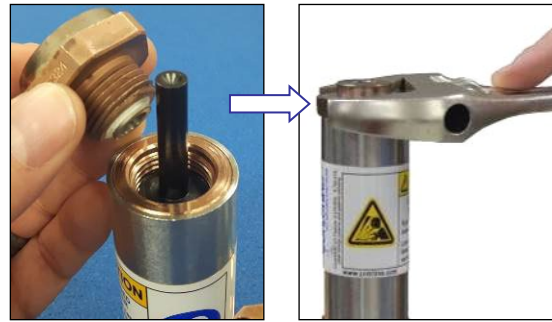

Servicing the Clamp Mount Style LVDT Electrode Assembly

Although the VeriFast LVDT Clamp Mount Assembly is a sealed, low maintenance device, the Weld Pin and the Electrode Head need to be replaced at regular intervals. In addition, by following the procedure illustrated below, other internal components can be inspected and/or replaced as needed.

Step 1

Remove the water service from the system.
Retract the weld pin to remove force internally on the weld head.



Step 2

Unthread and remove the Electrode Head from the Weld Body.

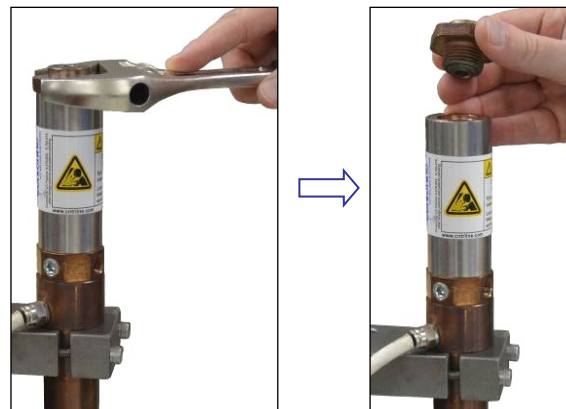

Step 3

Extend the weld pin to “service position” exposing the flats of the piston rod above the weld body. Then, remove the air from the system.

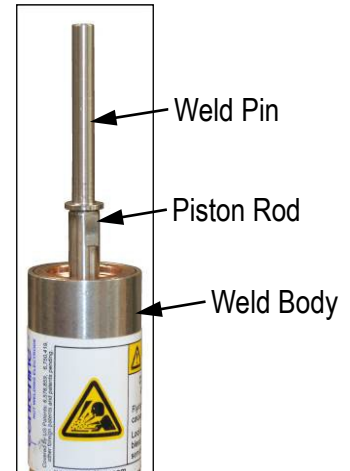

Step 4

Remove the weld pin from the piston rod.

If only the Pin and Head need to be replaced, the procedure ends here. To install a new Pin and Head, skip directly to Step 9 on page 46, then finish by reversing the steps performed to this point (Step 4 to Step 1).

If other internal components need to be inspected/replaced, continue with Step 5 below.

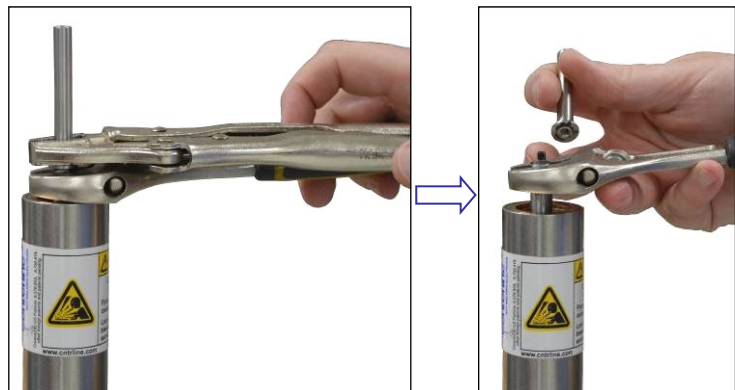

Step 5

Remove the LVDT insert from the base of the assembly.

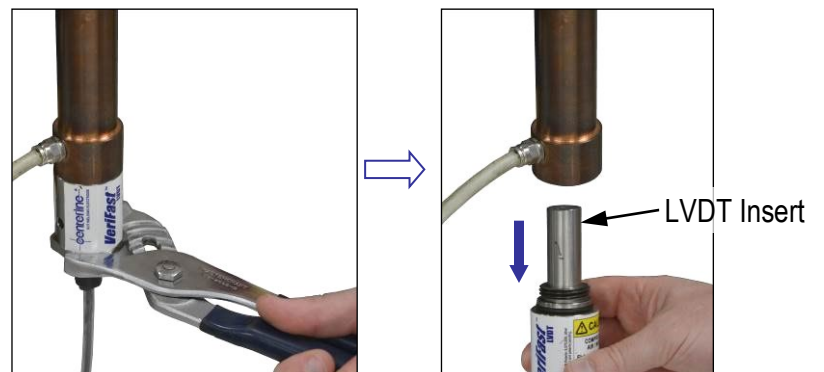

Step 6

Manually push the piston rod from above and it will pass through the bottom of the adapter.

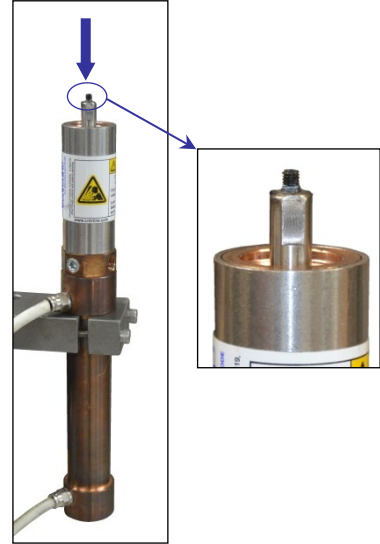

Step 7

Remove the piston rod assembly.



Step 8

Replace and lubricate O-rings if required.

Note: Magnalube-G grease is recommended for lubrication of O-rings and piston rod shaft.



Step 9

Inspect all components for wear and replace as needed. Assemble all components in reverse order, manually lowering the pin to ensure that the connecting rod properly aligns/inserts into the LVDT coil.

Note 1: Loctite 243 (Blue) is recommended when re-attaching the weld pin to the piston rod assembly. Allow sufficient curing time for the Loctite before resuming production.

Note 2: At the end of the re-assembly procedure, thread on the Electrode Head and tighten to the corresponding torque (according to the weld body series):

- 15 ft/lbs. – for Series 2 weld bodies
- 30 ft/lbs. – for Series 3 weld bodies
- 100 ft/lbs. – for Series 4 weld bodies.



Working Area Maintenance

Good housekeeping is an important element of any preventative maintenance program. Some cleaning should be done at regular intervals, usually when the electrodes are being changed. More extensive cleaning may occur during regular preventative maintenance of the equipment.

Cleaning the Equipment

IMPORTANT

The VeriFast LVDT assembly should be kept clean at all times.



Lockout Equipment

- Before starting to clean the VeriFast LVDT, ensure that the equipment is disconnected from all sources of power and is in the lockout state.
- Before turning ON the equipment, make sure all components are assembled properly.



Keep Dry

- Do not power wash the VeriFast LVDT.
- Do not immerse the VeriFast LVDT into water.

For optimal operation of the equipment, the VeriFast LVDT must be frequently inspected for contamination and buildup, and should be kept as clean as possible. The operating performance of the LVDT in the sensing process is highly dependent on the cleanliness and

good maintenance of the equipment. Excessive contamination and buildup reduce the performance accuracy and service life of the VeriFast.

A routine examination of the VeriFast LVDT should be performed on a regular basis to verify that all connections are tight and in good order.

The exterior of the VeriFast LVDT should be cleaned using the following guidelines:

- Clean the VeriFast as you would normally do with industrial equipment. Wipe the outside of the VeriFast with a dry, clean cloth.
- Use only dry ice or chemicals that are compatible with the materials used in the VeriFast and surrounding equipment (e.g., copper, brass, aluminum, carbon steel, stainless steel, and rubber (used as a protection for the LVDT)).
- Do not power wash. As mentioned above, dry ice can be used for proper cleaning.

Troubleshooting Quick Guide

Important Safety Information

Please review the *Safety Information* section starting on page 9 and *Personal Protective Equipment* section starting on page 10.

IMPORTANT

Follow all plant safety procedures and guidelines, as well as all safety instructions given in this manual before performing any troubleshooting procedures. Only certified personnel should perform any troubleshooting tasks on the machinery.

Troubleshooting Instructions



Lockout Equipment

- Before starting to troubleshoot the VeriFast LVDT, ensure that the equipment is disconnected from all sources of power and is in the lockout state.
- Before turning ON the equipment, make sure all components are assembled properly.

To troubleshoot the VeriFast LVDT unit, please refer to Table 4 that follows.

Table 4 – Troubleshooting the VeriFast LVDT

Problem:	Possible Cause:	What To Do:
Power ON, but no signal or value from VeriFast unit	Is the VeriFast LVDT unit connected / wired properly?	Confirm that the connection of the cable is fastened completely and firmly.
		Check the cable between the VeriFast LVDT unit and network connection for damage or compromise of integrity.
		Check control power supply.
		Refer to Table 1 on page 23 and Table 2 on page 24 to ensure correct wiring.
Cannot “Calibrate”	Is the VeriFast LVDT assembly connected?	Confirm wiring between the module and the main panel. See Table 1 on page 23.
		Verify operation LEDs of signal conditioner are in proper operating state. Refer to Table 3 on page 24.
		Confirm that the connecting cable is fastened completely and firmly.

Problem:	Possible Cause:	What To Do:
Cannot "Calibrate" (Continued)	Is the Weld Pin correct?	Verify that the LVDT connecting rod and core is present and firmly attached to the Weld Pin.
Measurement Value will not respond to Pin movement	Is the VeriFast LVDT unit connected / wired / calibrated properly?	Confirm wiring of the field connector. See Table 2 on page 24.
		Confirm proper wiring of the signal conditioner. See Table 1 on page 23.
		Refer to Table 3 on page 24 to ensure correct wiring.
		Confirm proper calibration according to the length of weld pin stroke (22 mm or 50 mm). Re-calibrate if necessary as shown in Re-Calibrating the Signal Conditioner (This procedure is rarely necessary) section starting on page 25.
Measurement Value responds but with reduced resolution and reverse of expected travel	Is the VeriFast LVDT unit connected / wired / calibrated properly?	To confirm wiring, refer to Table 1 on page 23 and Table 2 on page 24.
		Re-calibrate the signal conditioner (see <i>Re-Calibrating the Signal Conditioner</i> section on page 25.

Decommissioning

Preparing for Storage

The following guidelines should be followed when removing a VeriFast LVDT from service:

- Disconnect the VeriFast LVDT system from the external supplies (electrical, air) and identify the connections to facilitate a future installation.
- The storage location must be clean, dry, and not expose the VeriFast LVDT system to mechanical or thermal damage. If the VeriFast will be covered, there should be some air circulation to prevent condensation.

Appendix A – Signal Conditioner Connections and Specifications

Complete Signal Conditioner Electrical Connections

Table 5 – Complete Signal Conditioner Electrical Connections

Color	Terminal	Name	Function
White	1	SYNC I/O	Synchronization (Daisy chain for multiple units)
	2	ERROR DOUT*	Error Flag Output
	3	Primary Coil 1	Primary Excitation to LVDT
	4	Primary Coil 2	Primary Excitation to LVDT
Red	5	SHIELD**	Optional cable Shield connection
	6	NULL DOUT*	Remote Calibration Null Output
	7	Secondary Coil 1	Secondary signal from LVDT
	8	Secondary Coil 2	Secondary signal from LVDT
Blue	9	UP DOUT*	Remote Calibration UP Output
	10	DOWN DOUT*	Remote Calibration DOWN Output
	11	GND*, **	VOUT Return
	12	VDC OUT	Output Voltage
Black	13	ZERO DIN*	Remote Calibration ZERO Input
	14	FULL DIN*	Remote Calibration FULL Input
	15	-VIN (GND)**	Supply Voltage Return (0 V DC)
	16	+VIN	Supply Voltage In (+24 V DC)

* Used for remote calibration only.

** Terminals 5, 11 and 15 are internally connected.

Signal Conditioner Specifications

Table 6 – Signal Conditioner Specifications

Parameter	Value
Power:	
Input Voltage / Current	9 – 30 VDC, 90 mA max @ 24 VDC
Signal Output:	
Voltage Output	0-10 VDC
Frequency Response	100 Hz Max
Output Voltage Ripple	1 mV _{RMS} max
Output Non-Linearity	< ± 0.05% of FSO
Digital I/O:	
Input	Current Sink, High True (I = 3.0 mA Max., V = 30 VDC Max.)
Output	Open Collector, Low True (I = 50 mA Max., V = 30 VDC Max.)
Environmental:	
Temperature Coefficient	< 0.02% FRO/°C
Operating Temperature Range	-20°C to 75°C
Enclosure	4.5 x 3.9 x 0.9 in.
Features:	
Calibration	Via Front Panel Push Button or discrete digital I/O. Calibrated for use with 22 mm weld pin stroke. If 50 mm weld pin stroke is being used, see section <i>Re-Calibrating the Signal Conditioner</i> starting on page 25. Remote calibration is also available, see section <i>Re-Calibrating the Signal Conditioner Remotely</i> on page 26.
Synchronization Capability	Master/Slave Synchronization via single wire bus
Null Position Detection	Via Front Panel LEDs or discrete digital I/O
Error Detection	Primary or Secondary Wire Break Detect, indicated by blinking LEDs and Digital I/O

5

- 5-pin Shielded Cable/Connector
 - Wiring, 22
 - Wiring to Signal Conditioner, 22
 - Wiring to VeriFast LVDT Electrode, 23

B

- Base Mount LVDT Electrode, 13
 - Mounting, 20
 - Servicing the Assembly, 34

C

- Calibrating
 - Re-Calibrating the Signal Conditioner for Distinct Applications, 26
 - Re-Calibrating the Signal Conditioner for Most Applications, 25
 - Re-Calibrating the Signal Conditioner Remotely, 26
- Clamp Mount LVDT Electrode, 15
 - Mounting, 21
 - Servicing the Assembly, 43
- Cleaning Equipment, 46
- Coil, 12
- Components
 - VeriFast LVDT, 12
- Compressed Air. *See* Pneumatic
- Configuration
 - Base Mount Styles, 13
 - Clamp Mount Style, 15
 - SXZR Base Mount Style, 14
 - SYVR Extended Base Mount Style, 14
 - Tapered Mount Style, 15
 - Threaded Mount Style, 15
 - VeriFast LVDT, 13

- Connecting Rod Assembly, 12
- Connection

- Establish Pneumatic Service, 28
- Pneumatic for Clinching Applications, 31
- Pneumatic for LVDT Clamp Mount Weld Bodies with Non-Retractable Pin, 32
- Pneumatic for LVDT Clamp Mount Weld Bodies with Retractable Pin, 32
- Pneumatic for LVDT Weld Bodies with Non-Retractable Pin, 31
- Pneumatic for LVDT Weld Bodies with Retractable Pin using D3NC Valve, 29
- Pneumatic for LVDT Weld Bodies with Retractable Pin using DSCO Valve, 28
- Pneumatic for Weld Ring Projections Applications, 31

- Control Requirements, 17

D

- D3NC Valve, 29
- Decommissioning, 50
- DSCO Valve, 28

E

- Effective Resolution
 - Determining the, 27
 - Factors Affecting Analog Resolution, 27
 - Input Resolution, 28
 - Noise, 27
- Electrical Connections
 - Complete Electrical Connections for Signal Conditioner, 51, 52
- Electrical Supply Requirements, 17
- Electrode
 - Base Mount Styles, 13
 - Clamp Mount Style, 15
 - Pneumatic Connection for Clinching Applications, 31
 - Pneumatic Connection for LVDT Clamp Mount Weld Bodies with Non-Retractable Pin, 32
 - Pneumatic Connection for LVDT Clamp Mount Weld Bodies with Retractable Pin, 32

- Pneumatic Connection for LVDT Weld Bodies with Non-Retractable Pin, 31
- Pneumatic Connection for LVDT Weld Bodies With Retractable Pin using D3NC Valve, 29
- Pneumatic Connection for LVDT Weld Bodies With Retractable Pin using DSCO Valve, 28
- Pneumatic Connection for Weld Ring Projections Applications, 31
- Servicing the LVDT Base Mount Electrode, 34
- Servicing the LVDT Clamp Mount Electrode, 43
- Servicing the LVDT Electrode Assembly, 34, 38
- Servicing the LVDT Extended Base Mount Electrode, 34
- Servicing the LVDT SXZR Mount Electrode, 38
- Servicing the LVDT Tapered Mount Electrode, 34
- Servicing the LVDT Threaded Mount Electrode, 34
- SXZR Base Mount Style, 14
- SYVR Extended Base Mount Style, 14
- Tapered Mount Style, 15
- Threaded Mount Style, 15
- VeriFast LVDT Configuration, 13
- VeriFast LVDT Main Components, 12

Equipment

- Intended Use, 11
- Overview, 11
- Servicing the LVDT Electrode Assembly, 34, 38, 43

Extended Base Mount LVDT Electrode

- Servicing the Assembly, 34

F

Fastener

- Correct Orientation, 10, 12
- Detection and Orientation, 10, 12
- Error Detected Conditions, 10, 12
- Setting the Tolerance Windows, 33

H

Hazards

- Potential Hazards, 10

I

Installation, 19

- Mounting the Base Mount Electrode, 20
- Mounting the Signal Conditioner, 22
- Mounting the Tapered/Threaded/Clamp Mount LVDT Electrode, 21
- Pneumatic Service Connection, 28
- Pre-Installation Requirements, 19
- Pre-Installation Tips, 19
- Wiring the Signal Conditioner, 22
- Wiring the VeriFast LVDT, 22

Instructions

- Safety, 9

L

LED

- Operation, 24

LVDT Electrode. *See* Electrode

M

Maintenance, 34

- Cleaning Equipment, 46
- Servicing the LVDT Electrode Assembly, 34, 38, 43
- Working Area, 46

Mounting

- the LVDT Base Mount Electrode, 20
- the LVDT Tapered/Threaded/Clamp Mount Electrode, 21
- the Signal Conditioner, 22

N

No Fastener Detected Condition, 11

No Part Detected Condition, 11

Nut

- Detection and Orientation, 10, 12

Upside Down Condition, 11

P

Part Ordering for VeriFast LVDT, 16

Pneumatic

Connection for Clinching Applications, 31

Connection for LVDT Clamp Mount Weld Bodies with Non-Retractable Pin, 32

Connection for LVDT Clamp Mount Weld Bodies with Retractable Pin, 32

Connection for LVDT Weld Bodies with Non-Retractable Pin, 31

Connection for LVDT Weld Bodies with Retractable Pin using D3NC Valve, 29

Connection for LVDT Weld Bodies with Retractable Pin using DSCO Valve, 28

Connection for Weld Ring Projections Applications, 31

Pneumatic Supply Requirements, 17

Service Connection, 28

Pre-Installation

Requirements, 19

Tips, 19

Process Overview, 11

R

Re-Calibrating

the Signal Conditioner for Distinct Applications, 26

the Signal Conditioner for Most Applications, 25

the Signal Conditioner Remotely, 26

Required Services, 17

Control Requirements, 17

Electrical Requirements, 17

Pneumatic Supply Requirements, 17

Water Supply Requirements, 17

Requirements

Control, 17

Electrical Supply, 17

Pneumatic Supply, 17

Pre-Installation, 19

Water Supply, 17

Resolution. See Effective Resolution

S

Safety

Information, 9

Personal Protective Equipment, 10

Potential Hazards, 10

Services

Control Requirements, 17

Electrical Requirements, 17

Pneumatic Supply, 17

Water Supply, 17

Servicing

the Base Mount LVDT Electrode, 34

the Clamp Mount LVDT Electrode, 43

the Extended Base Mount LVDT Electrode, 34

the LVDT Electrode Assembly, 34, 38, 43

the SXZR Base Mount LVDT Electrode, 38

the Tapered Mount LVDT Electrode, 34

the Threaded Mount LVDT Electrode, 34

Set Point Values

No Fastener Detected, 11

No Part Detected, 11

Nut is Upside Down, 11

Weld Complete, 11

Weld Pin Extended Position, 11

Weld Pin Retracted Position, 11

Weld Proceed, 11

Setting the Tolerance Windows for Fasteners, 33

Setup, 33

Signal Conditioner

Complete Electrical Connections, 51, 52

Core Position LEDs, 24

Learning About, 24

Module Status, 24

Mounting, 22

Operation of LED Indicators, 24

Re-Calibrating for Distinct Applications, 26

Re-Calibrating for Most Applications, 25

Re-Calibrating Remotely, 26

Specifications, 51, 52

Synchronizing Multiple Signal Conditioners, 23

Wiring, 22

Wiring to 5-pin Shielded Cable, 23

Wiring to PLC, 23

Specifications

Control Requirements, 17

Electrical Requirements, 17

Pneumatic Requirements, 17

Signal Conditioner, 51

Water Flow Requirements, 18

Water Pressure Requirements, 18

Water Requirements, 17

Water Temperature Requirements, 18

Storage

Preparing for Storage, 50

SXZR Base Mount LVDT Electrode, 14

SXZR Mount Assembly

 Servicing the, 38

Synchronization of Multiple Signal Conditioners, 23

SYVR Extended Base Mount LVDT Electrode, 14

T

Tapered Mount LVDT Electrode, 15

 Mounting, 21

 Servicing the, 34

Threaded Mount LVDT Electrode, 15

 Mounting, 21

 Servicing the, 34

Tolerance

 Setting the Tolerance Windows, 33

Torque

 Electrode Head, 38, 43

 Pin Lock, 37, 42

 Weld Head, 46

Troubleshooting, 48

V

Valve

D3NC, 29

DSCO, 28

VeriFast LVDT

 Base Mount Style, 13

 Clamp Mount Style, 15

 Components, 12

 Configuration, 13

 Effective Resolution, 11

 Part Ordering, 16

 SXZR Base Mount Style, 14

 SYVR Extended Base Mount Style, 14

 Tapered Mount Style, 15

 Threaded Mount Style, 15

 Wiring, 22

 Wiring the Electrode to 5-pin Shielded Cable/Connector, 23

W

Water

 Flow, 18

 Pressure, 18

 Supply Requirements, 17

 Temperature, 18

Weld

 Body, 12

 Complete, 11

 Head, 12

 Pin, 12

 Pin Extended Position, 11

 Pin Retracted Position, 11

 Proceed, 11

Wiring

 5-pin Shielded Cable/Connector to VeriFast LVDT Electrode, 23

 Signal Conditioner to 5-pin Shielded Cable, 23

 Signal Conditioner to PLC, 23

 the 5-pin Shielded Cable, 22

 the Signal Conditioner, 22

 the VeriFast LVDT, 22

Working Area Maintenance, 46